

GeliG

Goods for green



2025 Produktprogramm
Product Program

Viva la vida!

VIVA: Unser neuestes Mitglied der Blumenkastenfamilie zielt nicht nur in farbenfroher Bepflanzung unser Cover.

Es ist auch eines unserer vielen neuen Produkte, die Sie ab Seite 12 entdecken können.

VIVA LA VIDA

VIVA: Did you spot the latest addition to our flower box range filled with colourful flowers on the front cover? It's one of our many new products, which you can find out more about starting on page 12.



AUF DEM COVER: VIVA Bewässerungsblumenkasten in Weiß, Produkt auf Seite 66
COVER: VIVA self-watering flower box, colour white, product on page 66

Alles neu? Nein, aber viele besser.

Wir haben die letzten Monate intensiv genutzt, um das Feedback unserer Kunden und unsere eigenen Erfahrungswerte in den neuen Katalog zu überführen. 10 Jahre hatte er uns und, so hoffen wir, auch Ihnen gute Dienste erwiesen. Nun wollen wir ihn für Sie noch besser machen. Das Ergebnis halten Sie in den Händen. Den Anfang macht der Rohstoff, das Papier. Hier setzen wir künftig auf ein 100% PEFC-zertifiziertes Papier, das ressourcenschonend hergestellt wird. Ein weiterer kleiner Baustein, um unserem Streben nach Nachhaltigkeit gerecht zu werden. Wie wir das Thema Nachhaltigkeit verstehen und welche Bausteine uns dabei am Herzen liegen, erfahren Sie auf Seite 8.

Doch auch strukturell haben wir den Katalog weiterentwickelt: So ist unser stetig gewachsenes Portfolio intuitiver aufgebaut und optisch besser gegliedert. Unser umfangreiches Zubehör ist nun in einer neuen Rubrik zusammengefasst. Neben den Produktinformationen sehen Sie hier, für welche Produkte das Zubehör geeignet ist. Die Tabellen sind nun den einzelnen Produkten zugeordnet und erleichtern Ihnen so die Suche nach den passenden Informationen. Hilfe bei der Suche bietet Ihnen künftig nicht nur das Inhaltsverzeichnis, sondern ein alphabetisch sortiertes Glossar am Ende dieses Katalogs. Den Anfang aber machen unsere Produktneuheiten ab Seite 12.

Wir wünschen Ihnen viel Freude mit dem neuen Katalog und natürlich mit unserer Geli-Produktwelt 2025.

ALL NEW? NO, BUT MUCH BETTER.

We've been working hard over the past few months to channel customer feedback and our own insights into our new catalogue. It has served us well for a decade – and we hope you have been able to say the same over the years. But now we're on a mission to improve it for you. You should be able to tell that already. That's because we've started with the paper it's printed on. From now on, we're only using PEFC-certified paper that's produced in an environmentally responsible way. This is another small step on our ongoing sustainability journey. You can read more about our commitment to the planet and our sustainability priorities on page 8.

We've also been working on the catalogue layout. As our product range keeps growing, it was important to us to present it in a more logical order that's easier to follow. You can now find all our accessories in one separate section. There you can read all the details and check which products the accessories are compatible with. The tables are linked to individual products now to make it easier for you to find the information you need. On that note, you can refer to the new alphabetical glossary at the end of this catalogue now as well as the contents. But we can get you started by telling you that the section on our new products starts on page 12.

We hope you enjoy our new catalogue and our Geli products for 2025!



P. Lippert

Pascal Lippert
Geschäftsführung / Managing Director



Günter

Günter Lippert
Geschäftsführung / Managing Director



N. Lippert

Nadine Lippert
Geschäftsführung / Managing Director

Inhaltsverzeichnis

Contents

Vorwort _____ 3
Introduction

Über Geli _____ 6
About Geli

Produktneuheiten _____ 12
New products



LIV ÜBERTOPF, INDOOR, 42



GARTENGISSKANNE, 22



CYLINDRO BLUMENTOPF, OUTDOOR, 102

Gießkannen _____ 16
Watering cans

Indoor _____ 28
Indoor

Gießkannen und Sprüher _____ 30
Watering cans and sprayers

Blumentöpfe _____ 40
Flower pots

Outdoor _____ 54
Outdoor

Blumenkästen _____ 56
Flower boxes

Bewässerungsblumenkästen _____ 64
Self-watering flower boxes

Urban Gardening _____ 84
Urban gardening

Pflanzgefäße _____ 94
Planters

Pflanztöpfe _____ 98
Planters

Pflanztröge _____ 114
Plant troughs

Blumenspindeln _____ 116
Urn planters

Containertöpfe _____ 117
Plant containers

Geländertöpfe _____ 120
Railing planters

Hängeampeln _____ 124
Hanging baskets

Pflanzschalen _____ 126
Bowl planters

Pflanzgefäße Serie Kubus _____ 128
Planters Kubus range

Pflanzgefäße Serie Rillen _____ 136
Planters Rillen range

Pflanzgefäße Serie Stone _____ 148
Planters Stone range

Pflanzgefäße Serie Napoli _____ 156
Planters Napoli range

Pflanzgefäße Serie Rimini _____ 162
Planters Rimini range

Pflanzgefäße Naturdesign _____ 168
Planters Nature design

Sonstiges _____ 182
Miscellaneous

Flexikorb _____ 184
Flexible basket

Dropman _____ 185
Dropman

Grabvasen _____ 186
Grave vases

Kanister _____ 188
Canister

Zubehör _____ 190
Accessories

Untersetzer Blumenkästen _____ 192
Flower box saucers

Halter Blumenkästen _____ 196
Flower box brackets

Untersetzer Töpfe Outdoor _____ 200
Flower pot saucers

Zubehör für Orchideen _____ 210
Accessories for orchids

Ersatzteile _____ 212
Spare parts

POS _____ 214
POS

Displayboxen _____ 216
Display boxes

Displayständer _____ 238
Display stands

Informationen _____ 246
Informations

Vertreterliste _____ 247
List of representatives

Glossar _____ 248
Glossary



Alle Trends und Neuheiten finden Sie auch auf unserer Homepage: www.geli.de/neu

You can also find all trends and new products on our website: www.geli.de/new

Unser neuer Katalog: die Neuerungen im Überblick

Nicht nur unsere Produkte, sondern auch deren Präsentation wollen wir permanent weiterentwickeln. Unser neuer Katalog vereint alle wichtigen Informationen zum Produkt, bietet Orientierung und soll Ihnen mit plakativen Bildwelten zeigen, wie gut sich unsere Goods for Green im Einsatz machen.

Das haben wir für Sie überarbeitet:

WHAT'S NEW IN OUR CATALOGUE?

We never stop striving to improve our products – and we want to keep finding even better ways to showcase them too. Our new catalogue brings together everything you need to know about our products, offers guidance and shows off our goods for green in action. These are the improvements we've made for you:

NEW

Neue Rubriken New categories

Unser stetig wachsendes Produktportfolio ist nun intuitiver gegliedert. Ein Inhaltsverzeichnis je Kapitel hilft, Produkte und Serien direkt zu finden. Die Farbcodes unterstützen weiterhin bei der schnelleren Orientierung.

We've presented our growing product portfolio in a more logical order. It's easier than ever for you to find specific products and ranges now that each section has its own table of contents. The colour coding will speed up the process too.

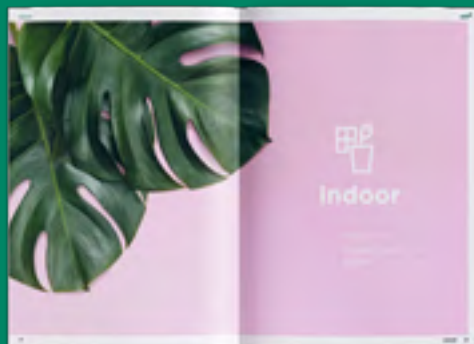

NEW

Produktübersichtsseiten Product overview pages

Den Produktkategorien ist künftig eine Übersichtsseite vorangestellt, die die gesamte Produktrange wie auch die allgemeingültigen Informationen der jeweiligen Kategorie übersichtlich abbildet.

Each product category starts with a summary page that introduces the entire range and provides general information about that category.



NEW

Neues Papier New paper



Auch den Katalog selbst haben wir unter dem Aspekt der Nachhaltigkeit auf den Prüfstand gestellt. Mit dem Wechsel des Papiers halten Sie nicht nur ein haptischeres Erlebnis, sondern auch ein 100% PEFC zertifiziertes Papier in den Händen.

We've extended our commitment to sustainability to the catalogue itself as well as the products on its pages. The paper we're using now feels good and does good since it's all PEFC-certified.

NEW

Informative Produkttabellen Informative product tables

Die Tabellen sind im Sinne der Funktion den einzelnen Produkten zugeordnet. So finden Sie nun alle produktspezifischen Informationen an einem Ort. Ein manuelles Zusammenbauen von Artikelnummern entfällt künftig (ausgenommen POS-Bereich).

Each product has its own table that contains everything you need to know about it. And you won't have to work out the product numbers for yourself anymore (with the exception of POS).

LIV ÜBERTOPF LIV CACHEPOT



● hellgrau / light grey (60)

ART.-NR. MODEL	GRÖSSE CA. Ø SIZE APPR.	HÖHE CA. HEIGHT APPR.	INHALT CA. VOLUME APPR.	VE PU
450 014 60	14	13,0	1,2	5
450 016 60	16	14,5	1,9	5
450 019 60	19	17,5	3,3	5
450 023 60	23	21,0	6,0	5
450 030 60	30	27,0	14,0	5
450 040 60	40	36,0	32,0	5

WEITERE INFORMATIONEN FURTHER DETAILS

Maßeinheiten sind nun noch unmissverständlicher benannt.

We've simplified the measurement units too to avoid confusion.

ERDVOLUMEN CA.
SOIL VOLUME APPR.
WASSERINHALT CA.
WATER-VOLUME APPR.

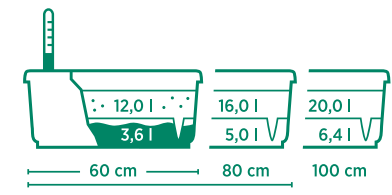

LÄNGE / LENGTH

NEW

Piktogramme zur Orientierung Pictograms as a guide

Produktfeatures sind grafisch gekennzeichnet. Product features are indicated by a symbol.



Zeigt an, dass ein Blumenkasten über ein Bewässerungssystem verfügt (Materialien inkl.).

This symbol indicates that a flower box has an irrigation system (materials included).



Zeigt an, dass für das Produkt POS-Materialien wie Sortimentspaletten, Displayboxen, -regale oder -ständer verfügbar sind.

This symbol indicates that POS materials are available for the product, such as range pallets and display boxes, shelves and stands.



Kennzeichnet Produkte, die ausschließlich aus recyceltem Kunststoff hergestellt sind.

This symbol is used for products that are made from 100% recycled plastic.



Das Zubehör und auch die Ersatzteile sind mit diesem Icon gekennzeichnet, inkl. Verweis auf die entsprechende Zubehörseite.

This symbol is used for accessories and spare parts along with a page reference for the accessories section.

NEW

Neuheiten sind ab sofort am Produkt gekennzeichnet.

New products are clearly marked with this symbol.

NEW

Zubehör an einem Ort Accessories in one place



Das Zubehör ist kompakt in einer eigenen Rubrik abgebildet. Dort wird auch direkt auf die dafür passenden Produkte verwiesen. So können Sie schnell und übersichtlich Produkt und Zubehör zusammenbringen.



Achten Sie auf das Plus-Symbol, das die zum Zubehör passenden Produkte kennzeichnet.

We've collated all our accessories in one separate section. You can find information about compatible products there too. It's much quicker and easier to match products with accessories now. Just look out for the plus symbol that tells you which products are compatible with which accessories.

NEW

Glossar Glossary

Sie wollen sich schnell anhand des Produktnamens orientieren? Unser neues Glossar auf Seite 248 hilft Ihnen dabei.

Want to find what you're looking for using the product name? Our new glossary on page 248 will help you with that.

Unsere RECY:
eine echt grüne Gartengießkanne
aus dem Gelben Sack

RECY:
our green garden watering can
from the yellow sack

Grün bis hinter die Ohren!

Grün hinter den Ohren? Das sind wir schon lange nicht mehr. „Goods for green“ stellen wir her, „good for green“ sind wir aus Überzeugung.

So haucht z.B. unsere Gartengießkanne RECY Haushaltsabfällen aus dem Gelben Sack neues Leben ein. Doch wir denken weiter und verstehen unser ganzes Handeln als einen Beitrag zum nachhaltigen Wirtschaften. Wir wollen mit unseren Produkten Natur und Pflanzen einen Lebensraum schenken und diesen auch langfristig erhalten.



MADE FROM 100% POST CONSUMER RECYCLED PLASTICS

GREEN THROUGH AND THROUGH!

Greenhorns? Absolutely not. We make 'goods for green' and we're committed to being 'good for green'.

That shines through in our actions and our products like the RECY garden watering can, which gives household recycling a new lease of life. But we're not happy to stop there. We pride ourselves on running a sustainable business in all that we do. Our aim is to provide a habitat for nature and plants with our products and maintain it over the long term.

AUF DIESER SEITE / ON THIS PAGE:
Max Redlich mit RECY Gartengießkanne aus dem gelben Sack, Produkt auf Seite 21 /
Max Redlich with the RECY garden watering can from the yellow sack, product on page 21



Recycled Plastics: unsere 100 % Recyclingprodukte

Unter der Produktlinie „Recycled Plastics“ bündeln wir unsere Produkte, die garantiert zu 100 % aus Recyclingmaterial hergestellt sind. Ein Teil unserer Basics ist bereits in unserer Recyclinglinie verfügbar.

RECYCLED PLASTICS - OUR 100 % RECYCLED PRODUCTS

Under the product line 'Recycled Plastics' we bundle products that are guaranteed to be made of 100% recycled material. Some of our basics are already available in our recycled line.

EIN AUSZUG UNSERER NACHHALTIGEN PRODUKTE: AN EXCERPT OF OUR SUSTAINABLE PRODUCTS:

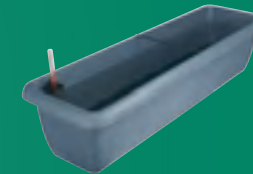

AQUA ANDALUCIA
AQUA ANDALUCIA
Seite / Page 76



AQUA GREEN
AQUA GREEN
Seite / Page 72



AZTEKI BLUMENTOPF
AZTEKI FLOWER POT
Seite / Page 106



CONNY / CONNY
Seite / Page 88



EASY / EASY
Seite / Page 86



LIV / LIV
Seite / Page 42



MONTANA BLUMENTOPF
MONTANA FLOWER POT
Seite / Page 104



MONTANA UNTERSETZER
MONTANA SAUCER
Seite / Page 202



STANDARD PFLANZSCHALE
STANDARD BOWL PLANTER
Seite / Page 127



**RECY GIESSKANNE
AUS DEM GELBEN SACK**
RECY WATERING CAN
FROM THE YELLOW SACK
Seite / Page 21



RECY GIESSKANNE
RECY WATERING CAN
Seite / Page 20



STANDARD BLUMENKASTEN
STANDARD FLOWER BOX
Seite / Page 58



STANDARD BLUMENTOPF
STANDARD FLOWER POT
Seite / Page 98



VIVA / VIVA
Seite / Page 66

Im Handel erkennen Sie unsere Recyclingprodukte am entsprechenden Etikett.

Our products made from recycled materials can be identified by the corresponding label in-store.



We act green. Wir handeln grün.

Damit aus unserem Nachhaltigkeitsansatz mehr als nur ein zartes Pflänzchen wird, treten wir jeden Tag an, um besser zu werden.

To ensure that our sustainability approach becomes more than just a tender seedling, we strive to improve every day.



Mehr als nur Recycling. Wir denken weiter.

Unsere Produktpalette an Recyclingprodukten wächst beständig. Darauf sind wir stolz. Mit unserem Zero-Waste-Ansatz sorgen wir dafür, dass wir unseren eigenen Ausschuss auf ein Minimum reduzieren und dem Kreislauf wieder zuführen. Doch nicht alles lässt sich aus Recyclingmaterial herstellen. Insbesondere bei der Farbe Weiß stößt das Wiederverwerten an seine Grenzen.

Aber wir bleiben daran, alle Möglichkeiten, die sich auftun, zu nutzen. Damit meinen wir auch den ganzheitlichen Blick auf unser Wirtschaften.

Unsere Nachhaltigkeitsstrategie ist uns dabei Leitbild und Verpflichtung gleichermaßen.

MORE THAN JUST RECYCLING. WE TAKE IT ONE STEP FURTHER.

We keep adding to our range of recycled products. And we're proud of it. We're committed to our zero-waste strategy, which means we keep our own waste to a minimum and recycle whenever we can. But it's not possible to make everything out of recycled materials. The colour white is one significant limitation when it comes to recycling.

That doesn't stop us from seizing every opportunity that presents itself, though. And we apply that attitude to the way we run our business as a whole.

Our sustainability strategy guides and defines our actions

We are good for green. Wir sind good for green.

Die Säulen unserer Nachhaltigkeitsstrategie:

THE CORE PRINCIPLES OF OUR SUSTAINABILITY STRATEGY:



ZERO-WASTE PRODUKTION / ZERO-WASTE PRODUCTION

Unser Ziel: den eigenen Ausschuss auf ein Minimum reduzieren und dem Kreislauf wieder zuführen.

Our goal: To minimise our own waste and recycle whenever we can.



ENERGIE-EFFIZIENZ / ENERGY EFFICIENCY

Unser Ziel: mit kurzen Wegen und intelligentem Energiemanagement Ressourcen effizient nutzen.

Our goal: To use resources efficiently by sourcing them as locally as possible and managing them intelligently.



NACHHALTIGE RESSOURCEN / SUSTAINABLE RESOURCES

Unser Ziel: als gesamtes Unternehmen verantwortungsvoll und umsichtig handeln. Der Einsatz von recycelten Rohstoffen ist nur ein Baustein davon.

Our goal: To take responsibility collectively as a business and act with caution and care. The use of recycled raw materials is just one aspect of this goal.



STANDORT DEUTSCHLAND / BASED IN GERMANY

Unser Ziel: Wir stärken die Region und sichern die Qualität unserer Produkte.

Our goal: To strengthen the region and guarantee the high quality of our products.



TRANSPARENZ / TRANSPARENCY

Unser Ziel: Wir verfolgen unsere ganzheitlich angelegte Strategie mit Nachdruck. Das wollen wir zeigen - klar, transparent und ungeschönt. Wir sind auf dem Weg.

Our goal: To do everything in our power to follow our overall strategy, ensuring clarity, transparency and honesty along the way. We are making progress here.

Unsere Produktneuheiten. Our new products.

A perfect match!

Zwei aus einem gestalterischen Guss: Unsere State-of-the-Art-Interpretation von Sprüher und Blumengießkanne wertet moderne Innenräume auf. Das klare Design im Bicolor-Look gibt es in vielen zeitgemäßen Farben und in vier transparenten Varianten.

Two designs that were made to go together. Our state-of-the-art take on the sprayer and watering can looks good in any modern indoor space. The clean, two-tone design comes in a range of on-trend colours and in four transparent versions.

INDOOR BLUMENGIESSKANNE UND SPRÜHER CAPRI



NEW
IN
2024

CAPRI GIESSKANNE UND SPRÜHER
CAPRI WATERING CAN AND SPRAYER

ART.-NR. 753 ... ART.-NR. 754 ... SEITE 32
MODEL MODEL PAGE



NEW

INDOOR
BLUMENTOPF
TUBO

TUBO ÜBERTOPF
TUBO CACHEPOT

ART.-NR. 488 ... SEITE 44
MODEL PAGE

It goes round and round.

Mit MILLY und TUBO ergänzen zwei elegante Indoor-Blumentöpfe unser Sortiment. Während MILLY mit einer feinen Streifenoptik glänzt, überlässt TUBO mit einer gänzlich reduzierten Oberfläche den Pflanzen die Bühne. Beide Töpfe sind randlos, schlicht, geradlinig und in vier zeitgemäßen Farben erhältlich.

We're delighted to welcome two elegant indoor flower pots to the range. Say hello to MILLY and TUBO. MILLY has a sophisticated stripy look, while TUBO is deliberately understated to make the plants the star of the show. Both pots are sleek with straight lines and no rim. And each comes in four modern colours.

MILLY ÜBERTOPF
MILLY CACHEPOT

ART.-NR. 487 ... SEITE 46
MODEL PAGE



NEW

INDOOR
BLUMENTOPF
MILLY

BEWÄSSERUNGS-
BLUMENKASTEN
VIVA **Viva la
vida!**



NEW

RECYCLED*
PLASTICS

PASSEND DAZU
**UNIVERSAL BLUMEN-
KASTENHALTER**



NEW

UNIVERSAL BLUMENKASTENHALTER
UNIVERSAL FLOWER BOX BRACKET

ART.-NR. 39 816 ...
MODEL

SEITE 197
PAGE

Unser neuestes Mitglied der Blumenkastenfamilie. Mit einem exklusiv für uns entwickelten Design, das markant und trotzdem zurückgenommen ist. Der prägnante Rand ist elegant und praktisch zugleich, denn er verleiht dem Kasten noch mehr Stabilität. Ein besonderes Designelement findet sich am Boden: Ein nach innen versetzter Rand erzeugt eine Schattenfuge und lässt den Kasten auf dem Boden stehend schwebend wirken.

This is the newest addition to our flower box range. It has an exclusive design that makes its own understated statement. The distinctive rim is elegant yet practical because it makes the flower box more stable. And there's another special design touch at the bottom. The hidden offset edge creates a shadow gap so it looks like the flower box is floating.

*Farbe Weiß (10) ausgenommen /
colour white (10) excluded

VIVA BEWÄSSERUNGSBLUMENKASTEN
VIVA SELF-WATERING FLOWER BOX

ART.-NR. 820 ... SEITE 66
MODEL PAGE

LIV ÜBERTOPF
LIV CACHEPOT

ART.-NR. 450 ... SEITE 42
MODEL PAGE

**Liv up your
home!**

Dieser randlose Topf ist zeitlos und trifft mit seinem minimalistischen Design den Zeitgeist. Seine seidenmatte Oberfläche lässt Licht und Farbe noch besser wirken. Unser Bestseller ist in vielen Farben erhältlich.

This pot without a rim is timeless and also right on trend with its minimalist design. The smooth matt finish intensifies the effects of light and colour. Our bestseller comes in a wide range of colours.



NEW

INDOOR
**BLUMENTOPF
LIV**

RECYCLED*
PLASTICS



Gießkannen

Unsere Gießkannen

Our watering cans



i **UNSERE GIESSKANNEN ERHALTEN SIE INKL. BRAUSE. ERSATZBRAUSEN FINDEN SIE IM KAPITEL ZUBEHÖR AUF SEITE 212.**
OUR WATERING CANS COME WITH THE ROSE INCLUDED. YOU CAN FIND REPLACEMENT ROSES IN THE ACCESSORIES SECTION ON PAGE 212.

Gießkanne mit Aufsteckvorrichtung für die Brause (10, 14 Ltr.)

Unsere Gartengießkanne verfügt über eine praktische Aufsteckvorrichtung für die Brause. Benötigt man die Brause nicht, kann sie einfach auf die Vorrichtung gesteckt werden – so ist sie immer griffbereit an der Gießkanne und im Handumdrehen gewechselt.

WATERING CAN WITH ROSE HOLDER (10, 14 LTR.)

Our garden watering can has a handy attachment for the rose. If the rose is not required, it can simply be attached to the watering can to be always ready to hand and it can be switched in no time.

Jede Kanne ein Stück Geschichte ...

... und die begann in den 50-er Jahren mit den Blechgießkannen der Firma Lippert. Unsere Gartengießkanne Antiqua lässt die historische Form heute neu aufblühen. Dabei muss sie sich nicht verstecken, sondern ist ein echter Blickfang im Garten.

Bekannt sind wir für unsere Kunststoffgießkannen aus einem Guss. Hergestellt im modernsten Blasverfahren, haben mittlerweile über 150 Millionen Gießkannen unsere Produktion verlassen und die Welt grüner gemacht.

A PIECE OF HISTORY

It all began back in the 1950s with the Lippert tin watering cans. Our Antiqua garden watering can is giving the old design another chance to blossom. And it deserves to have pride of place out in the garden. We're known for our plastic watering cans made in a single cast. Over 150 million watering cans made with our state-of-the-art blow moulding process have already been sent out to make the world a greener place.



Die erste „Geli-Gießkanne“ der Gebrüder Lippert aus dem Jahr 1949, bekannt als „verzinkte Friedhofsgießkanne“.
The first Geli watering can made by the Lippert brothers in 1949, known as the 'galvanised graveyard watering can'.

UNSERE GIESSKANNEN / OUR WATERING CANS:



RECYCLED PLASTICS

RECY GARTENGISSKANNE RECY GARDEN WATERING CAN



Seite / Page 20



RECYCLED PLASTICS

RECY GARTENGISSKANNE AUS DEM GELBEN SACK RECY GARDEN WATERING CAN FROM THE YELLOW SACK



Seite / Page 21



+ POS SYSTEM

GARTENGISSKANNE GARDEN WATERING CAN



Seite / Page 22



+ POS SYSTEM

BLUMENGISSKANNE FLOWER WATERING CAN



Seite / Page 24



ANTIQUA GARTENGISSKANNE ANTIQUA GARDEN WATERING CAN



Seite / Page 26

PRODUKTE AUF DIESER SEITE / PRODUCTS ON THIS PAGE:
Gartengießkanne in hellblau, lila und mintgrün / Garden watering can in light blue, purple and mint green



RECY

GARTENGISSKANNE
GARDEN WATERING CAN

FARBE
Es kann produktionsbedingt zu Farbschwankungen kommen.
The actual colours may vary due to factors during production.

**RECY GARTENGISSKANNE
AUS DEM GELBEN SACK**
RECY GARDEN WATERING CAN
FROM THE YELLOW SACK



● recy-hellgrau / recy light grey (09)

ART.-NR. MODEL	INHALT CA. VOLUME APPR.	VE PU
1200 702 010 09	10	12



**WIR MACHEN GELB ZU GRÜN: UNSER NEUESTES
GISSKANNENMODELL RECY BESTEHT ZU 100% AUS
RECYCLINGKUNSTSTOFFEN AUS DEM HAUSHALTSAB-
FALL – DEM GELBEN SACK BZW. DER GELBEN TONNE.**
OUR LATEST WATERING CAN MODEL RECY IS MADE FROM 100%
RECYCLED PLASTICS FROM HOUSEHOLD WASTE – DISPOSED
OF IN THE YELLOW SACK OR YELLOW BIN.

YELLOW GOES GREEN!

MADE FROM 100% POST CONSUMER RECYCLED PLASTICS MORE INFO!

geli GmbH
Am Goldbach 1
63755 Alzenau
Germany
www.geli.de

GISSKANNE RECY
ca. 10 ltr. recy-hellgrau
1200702 010 09

4 10 00 15 0 0 2 1 8 6 9

ERKENNBAR AM „YELLOW GOES GREEN!“-ETIKETT
IDENTIFIABLE BY THE "YELLOW GOES GREEN!"-LABEL



FARBE
Es kann produktionsbedingt zu Farbschwankungen kommen.
The actual colours may vary due to factors during production.

RECY

GARTENGISSKANNE AUS DEM GELBEN SACK
GARDEN WATERING CAN FROM THE YELLOW SACK

RECY GARTENGISSKANNE
RECY GARDEN WATERING CAN



● recy-dunkelgrau / recy dark grey (99)

ART.-NR. MODEL	INHALT CA. VOLUME APPR.	VE PU
1200 702 010 99	10	12



**NACHHALTIGE RECYCLING
GISSKANNE. ZU 100% AUS
RECYCELTEN ROHSTOFFEN
MIT MEHR ALS 50% POST-
CONSUMER-ANTEIL.**
SUSTAINABLE RECYCLING
WATERING CAN. MADE FROM
100% RECYCLED RAW MATERIALS
WITH A POST-CONSUMER-
PROPORTION OF MORE THAN 50%.



GARTEN- GISSKANNE

MIT AUFSTECKVORRICHTUNG
GARDEN WATERING CAN WITH ROSE HOLDER



● gelb / yellow (02)



ART.-NR. MODEL	INHALT CA. VOLUME APPR.	VE PU
702 005 02	5	10
1200 702 010 02	10	12

● rot / red (04)



ART.-NR. MODEL	INHALT CA. VOLUME APPR.	VE PU
702 005 04	5	10
1200 702 010 04	10	12

● pistazie / pistachio (20)



ART.-NR. MODEL	INHALT CA. VOLUME APPR.	VE PU
702 005 20	5	10
1200 702 010 20	10	12

● blau / blue (24)



ART.-NR. MODEL	INHALT CA. VOLUME APPR.	VE PU
702 005 24	5	10
1200 702 010 24	10	12

● mintgrün / mint green (31)



ART.-NR. MODEL	INHALT CA. VOLUME APPR.	VE PU
702 005 31	5	10
1200 702 010 31	10	12

● orange / orange (32)



ART.-NR. MODEL	INHALT CA. VOLUME APPR.	VE PU
-	5	-
1200 702 010 32	10	12

● hellblau / light blue (33)



ART.-NR. MODEL	INHALT CA. VOLUME APPR.	VE PU
-	5	-
1200 702 010 33	10	12

● lila / purple (34)



ART.-NR. MODEL	INHALT CA. VOLUME APPR.	VE PU
-	5	-
1200 702 010 34	10	12

● anthrazit / anthracite (38)



ART.-NR. MODEL	INHALT CA. VOLUME APPR.	VE PU
702 005 38	5	10
1200 702 010 38	10	12

● pink / pink (43)



ART.-NR. MODEL	INHALT CA. VOLUME APPR.	VE PU
702 005 43	5	10
1200 702 010 43	10	12

● hellgrau / light grey (60)



ART.-NR. MODEL	INHALT CA. VOLUME APPR.	VE PU
-	5	-
1200 702 010 60	10	12

● zartrosa / soft pink (86)



ART.-NR. MODEL	INHALT CA. VOLUME APPR.	VE PU
-	5	-
1200 702 010 86	10	12

ERSATZTEIL
SPARE PART

ERSATZBRAUSEN SCHWARZ REPLACEMENT ROSES BLACK



SEITE 212
PAGE

INHALT GIESSKANNE VOLUME WATERING CAN	PASSENDE BRAUSE MATCHING ROSE
5 Liter / 5 litres	712 005 14
10 Liter / 10 litres	712 014 14
14 Liter / 14 litres	712 014 14

GARTENGISSKANNE GARDEN WATERING CAN



SEITE 216
PAGE

● grün / green (01)



ART.-NR. MODEL	INHALT CA. VOLUME APPR.	VE PU
702 005 01	5	10
1200 702 010 01	10	12
702 014 01	14	10



BLUMEN- GISSSKANNE

FLOWER WATERING CAN



BLUMENGISSKANNE FLOWER WATERING CAN



SEITE 217
PAGE

● gelb / yellow (02)



ART.-NR. MODEL	INHALT CA. VOLUME APPR.	VE PU
702 001 02	1	10
702 002 02	2	10

● rot / red (04)



ART.-NR. MODEL	INHALT CA. VOLUME APPR.	VE PU
702 001 04	1	10
702 002 04	2	10

● pistazie / pistachio (20)



ART.-NR. MODEL	INHALT CA. VOLUME APPR.	VE PU
702 001 20	1	10
702 002 20	2	10

● blau / blue (24)



ART.-NR. MODEL	INHALT CA. VOLUME APPR.	VE PU
702 001 24	1	10
702 002 24	2	10

● mintgrün / mint green (31)



ART.-NR. MODEL	INHALT CA. VOLUME APPR.	VE PU
702 001 31	1	10
702 002 31	2	10

● orange / orange (32)



ART.-NR. MODEL	INHALT CA. VOLUME APPR.	VE PU
702 001 32	1	10
-	2	-

ERSATZTEIL
SPARE PART

ERSATZBRAUSEN SCHWARZ REPLACEMENT ROSES BLACK



SEITE 212
PAGE



INHALT GISSKANNE VOLUME WATERING CAN	PASSENDEN BRAUSE MATCHING ROSE
1 Liter / 1 litres	712 001 14
2 Liter / 2 litres	712 003 14
3 Liter / 3 litres	712 003 14

● grün / green (01)



ART.-NR. MODEL	INHALT CA. VOLUME APPR.	VE PU
702 001 01	1	10
702 002 01	2	10
702 003 01	3	10

● hellblau / light blue (33)



ART.-NR. MODEL	INHALT CA. VOLUME APPR.	VE PU
702 001 33	1	10
702 002 33	2	10

● anthrazit / anthracite (38)



ART.-NR. MODEL	INHALT CA. VOLUME APPR.	VE PU
702 001 38	1	10
702 002 38	2	10

● pink / pink (43)



ART.-NR. MODEL	INHALT CA. VOLUME APPR.	VE PU
702 001 43	1	10
702 002 43	2	10

Volumen in Liter / volume in litres

Produktinformation / Product information:



ANTIQUA

GARTENGISSKANNE
GARDEN WATERING CAN



ANTIQUA GARTENGISSKANNE ANTIQUA GARDEN WATERING CAN



● dunkelgrün / dark green (11)

ART.-NR. MODEL	INHALT CA. VOLUME APPR.	VE PU
701 005 11	5	8
701 010 11	10	8



● zink / zinc-coloured (42)

ART.-NR. MODEL	INHALT CA. VOLUME APPR.	VE PU
701 005 42	5	8
701 010 42	10	8

ERSATZTEIL
SPARE PART

ERSATZBRAUSEN FÜR ANTIQUA
REPLACEMENT ROSES ANTIQUA

●

SEITE 212
PAGE



INHALT GIESSKANNE VOLUME WATERING CAN	PASSENDE BRAUSE MATCHING SAUCER
5 Liter / 5 litres	712 005 41
10 Liter / 10 litres	712 014 41





Indoor

Übersicht / Overview

Gießkannen und Sprüher _____ 30
Watering cans and sprayers

Blumentöpfe _____ 40
Flower Pots

Indoor Gießkannen und Sprüher

Indoor watering cans and sprayers



UNSERE INDOOR GIESSKANNEN UND SPRÜHER /
OUR INDOOR WATERING CANS AND SPRAYERS:



CAPRI BLUMENGIESSKANNE UND SPRÜHER
CAPRI WATERING CAN AND SPRAYER



Seite / Page 32



EDEN BLUMENGIESSKANNE UND SPRÜHER
EDEN WATERING CAN AND SPRAYER



Seite / Page 34



FASHION BLUMENGIESSKANNE UND SPRÜHER
FASHION WATERING CAN AND SPRAYER



Seite / Page 36



STANDARD SPRÜHER
STANDARD SPRAYER



Seite / Page 38

PRODUKTE AUF DIESER SEITE / PRODUCTS ON THIS PAGE:
CAPRI Gießkanne in weiß, zartrosa und betonfarbe /
CAPRI Watering can in white, soft pink and concrete colour

CAPRI

BLUMENGISSKANNE & SPRÜHER
WATERING CAN & SPRAYER



NEW
IN
2024

CAPRI BLUMENGISSKANNE & CAPRI SPRÜHER

CAPRI WATERING CAN & CAPRI SPRAYER



DISPLAYSTÄNDER
DISPLAY STAND

SEITE 238
PAGE



○ weiß / white (10)

BLUMENGISSKANNE WATERING CAN

ART.-NR. MODEL	INHALT CA. VOLUME APPR.	VE PU
753 001 10	1,3	5

○ weiß / white (10)

SPRÜHER SPRAYER

ART.-NR. MODEL	INHALT CA. VOLUME APPR.	VE PU
754 007 10	0,75	5



○ transparent klar / transparent clear (70)

BLUMENGISSKANNE WATERING CAN

ART.-NR. MODEL	INHALT CA. VOLUME APPR.	VE PU
753 001 70	1,3	5

○ transparent klar / transparent clear (70)

SPRÜHER SPRAYER

ART.-NR. MODEL	INHALT CA. VOLUME APPR.	VE PU
754 007 70	0,75	5



○ eukalyptus / eucalyptus (68)

BLUMENGISSKANNE WATERING CAN

ART.-NR. MODEL	INHALT CA. VOLUME APPR.	VE PU
753 001 68	1,3	5

○ eukalyptus / eucalyptus (68)

SPRÜHER SPRAYER

ART.-NR. MODEL	INHALT CA. VOLUME APPR.	VE PU
754 007 68	0,75	5



○ betonfarbe / concrete colour (59)

BLUMENGISSKANNE WATERING CAN

ART.-NR. MODEL	INHALT CA. VOLUME APPR.	VE PU
753 001 59	1,3	5

○ betonfarbe / concrete colour (59)

SPRÜHER SPRAYER

ART.-NR. MODEL	INHALT CA. VOLUME APPR.	VE PU
754 007 59	0,75	5



○ transparent eukalyptus / transparent eucalyptus (74)

BLUMENGISSKANNE WATERING CAN

ART.-NR. MODEL	INHALT CA. VOLUME APPR.	VE PU
753 001 74	1,3	5

○ transparent eukalyptus / transparent eucalyptus (74)

SPRÜHER SPRAYER

ART.-NR. MODEL	INHALT CA. VOLUME APPR.	VE PU
754 007 74	0,75	5



○ transparent anthrazit / transparent anthracite (69)

BLUMENGISSKANNE WATERING CAN

ART.-NR. MODEL	INHALT CA. VOLUME APPR.	VE PU
753 001 69	1,3	5

○ transparent anthrazit / transparent anthracite (69)

SPRÜHER SPRAYER

ART.-NR. MODEL	INHALT CA. VOLUME APPR.	VE PU
754 007 69	0,75	5



○ zartrosa / soft pink (86)

BLUMENGISSKANNE WATERING CAN

ART.-NR. MODEL	INHALT CA. VOLUME APPR.	VE PU
753 001 86	1,3	5

○ zartrosa / soft pink (86)

SPRÜHER SPRAYER

ART.-NR. MODEL	INHALT CA. VOLUME APPR.	VE PU
754 007 86	0,75	5



○ transparent zartrosa / transparent soft pink (75)

BLUMENGISSKANNE WATERING CAN

ART.-NR. MODEL	INHALT CA. VOLUME APPR.	VE PU
753 001 75	1,3	5

○ transparent zartrosa / transparent soft pink (75)

SPRÜHER SPRAYER

ART.-NR. MODEL	INHALT CA. VOLUME APPR.	VE PU
754 007 75	0,75	5



EDEN

BLUMENGISSKANNE & SPRÜHER
WATERING CAN & SPRAYER



**EDEN BLUMENGISSKANNE
& EDEN SPRÜHER**
EDEN WATERING CAN
& EDEN SPRAYER

● gelb / yellow (02)



BLUMENGISSKANNE WATERING CAN

ART.-NR. MODEL	INHALT CA. VOLUME APPR.	VE PU
32 740 002 02	2	5

● gelb / yellow (02)

SPRÜHER SPRAYER

ART.-NR. MODEL	INHALT CA. VOLUME APPR.	VE PU
32 741 090 02	0,9	5

○ weiß / white (10)



BLUMENGISSKANNE WATERING CAN

ART.-NR. MODEL	INHALT CA. VOLUME APPR.	VE PU
32 740 002 10	2	5

○ weiß / white (10)

SPRÜHER SPRAYER

ART.-NR. MODEL	INHALT CA. VOLUME APPR.	VE PU
32 741 090 10	0,9	5

● hellblau / light blue (33)



BLUMENGISSKANNE WATERING CAN

ART.-NR. MODEL	INHALT CA. VOLUME APPR.	VE PU
32 740 002 33	2	5

● hellblau / light blue (33)

SPRÜHER SPRAYER

ART.-NR. MODEL	INHALT CA. VOLUME APPR.	VE PU
32 741 090 33	0,9	5

● mintgrün / mint green (31)



BLUMENGISSKANNE WATERING CAN

ART.-NR. MODEL	INHALT CA. VOLUME APPR.	VE PU
32 740 002 31	2	5

● mintgrün / mint green (31)

SPRÜHER SPRAYER

ART.-NR. MODEL	INHALT CA. VOLUME APPR.	VE PU
32 741 090 31	0,9	5

● anthrazit / anthracite (38)



BLUMENGISSKANNE WATERING CAN

ART.-NR. MODEL	INHALT CA. VOLUME APPR.	VE PU
32 740 002 38	2	5

● anthrazit / anthracite (38)

SPRÜHER SPRAYER

ART.-NR. MODEL	INHALT CA. VOLUME APPR.	VE PU
32 741 090 38	0,9	5

● eukalyptus / eucalyptus (68)



BLUMENGISSKANNE WATERING CAN

ART.-NR. MODEL	INHALT CA. VOLUME APPR.	VE PU
32 740 002 68	2	5

● eukalyptus / eucalyptus (68)

SPRÜHER SPRAYER

ART.-NR. MODEL	INHALT CA. VOLUME APPR.	VE PU
32 741 090 68	0,9	5

● zartrosa / soft pink (86)



BLUMENGISSKANNE WATERING CAN

ART.-NR. MODEL	INHALT CA. VOLUME APPR.	VE PU
32 740 002 86	2	5

● zartrosa / soft pink (86)

SPRÜHER SPRAYER

ART.-NR. MODEL	INHALT CA. VOLUME APPR.	VE PU
32 741 090 86	0,9	5



FASHION

BLUMENGIESSKANNE & SPRÜHER WATERING CAN & SPRAYER



FASHION BLUMENGIESSKANNE & FASHION SPRÜHER FASHION WATERING CAN & FASHION SPRAYER

● gelb / yellow (02)



BLUMENGIESSKANNE WATERING CAN

ART.-NR. MODEL	INHALT CA. VOLUME APPR.	VE PU
330 001 02	1,4	10

● gelb / yellow (02)

SPRÜHER SPRAYER

ART.-NR. MODEL	INHALT CA. VOLUME APPR.	VE PU
331 090 02	0,9	10

● mintgrün / mint green (31)



BLUMENGIESSKANNE WATERING CAN

ART.-NR. MODEL	INHALT CA. VOLUME APPR.	VE PU
330 001 31	1,4	10

● mintgrün / mint green (31)

SPRÜHER SPRAYER

ART.-NR. MODEL	INHALT CA. VOLUME APPR.	VE PU
331 090 31	0,9	10

● creme / creme (35)



BLUMENGIESSKANNE WATERING CAN

ART.-NR. MODEL	INHALT CA. VOLUME APPR.	VE PU
330 001 35	1,4	10

● creme / creme (35)

SPRÜHER SPRAYER

ART.-NR. MODEL	INHALT CA. VOLUME APPR.	VE PU
331 090 35	0,9	10

● anthrazit / anthracite (38)



BLUMENGIESSKANNE WATERING CAN

ART.-NR. MODEL	INHALT CA. VOLUME APPR.	VE PU
330 001 38	1,4	10

● anthrazit / anthracite (38)

SPRÜHER SPRAYER

ART.-NR. MODEL	INHALT CA. VOLUME APPR.	VE PU
331 090 38	0,9	10

STANDARD

SPRÜHER
SPRAYER



STANDARD SPRÜHER
STANDARD SPRAYER

● gelb / yellow (02)



ART.-NR. MODEL	INHALT CA. VOLUME APPR.	VE PU
730 052 02	0,5	10
730 102 02	1,0	10

● rot / red (04)



ART.-NR. MODEL	INHALT CA. VOLUME APPR.	VE PU
730 052 04	0,5	10
730 102 04	1,0	10

○ weiß / white (10)



ART.-NR. MODEL	INHALT CA. VOLUME APPR.	VE PU
730 052 10	0,5	10
730 102 10	1,0	10

● blau / blue (24)



ART.-NR. MODEL	INHALT CA. VOLUME APPR.	VE PU
730 052 24	0,5	10
730 102 24	1,0	10





Blumentöpfe Indoor

Flower pots indoor

UNSERE INDOOR BLUMENTÖPFE /
OUR INDOOR FLOWER POTS:

+ POS SYSTEM
RECYCLED PLASTICS



LIV ÜBERTOPF
LIV CACHEPOT



Seite / Page 42



NEW

TUBO ÜBERTOPF
TUBO CACHEPOT



Seite / Page 44



NEW

MILLY ÜBERTOPF
MILLY CACHEPOT



Seite / Page 46



CASABLANCA ÜBERTOPF
CASABLANCA CACHEPOT



Seite / Page 48

+ POS SYSTEM



PURE ÜBERTOPF
PURE CACHEPOT



Seite / Page 50



ORCHIDEENTOPF
ORCHID POT



Seite / Page 52

PRODUKTE AUF DIESER SEITE / PRODUCTS ON THIS PAGE:
LIV Übertopf in sand und beerenrot / LIV cachepot in sand and berry



LIV

ÜBERTOPF CACHEPOT

LIV ÜBERTOPF LIV CACHEPOT

RECYCLED PLASTICS 

+ POS SYSTEM 

SEITE 218
PAGE

 weiß / white (10)



ART.-NR. MODEL	GRÖSSE CA. Ø SIZE APPR.	HÖHE CA. HEIGHT APPR.	INHALT CA. VOLUME APPR.	VE PU
450 014 10	14	13,0	1,2	5
450 016 10	16	14,5	1,9	5
450 019 10	19	17,5	3,3	5
450 023 10	23	21,0	6,0	5
450 030 10	30	27,0	14,0	5
450 040 10	40	36,0	32,0	5

 sand / sand (16)



ART.-NR. MODEL	GRÖSSE CA. Ø SIZE APPR.	HÖHE CA. HEIGHT APPR.	INHALT CA. VOLUME APPR.	VE PU
450 014 16	14	13,0	1,2	5
450 016 16	16	14,5	1,9	5
450 019 16	19	17,5	3,3	5
450 023 16	23	21,0	6,0	5
450 030 16	30	27,0	14,0	5
450 040 16	40	36,0	32,0	5

 beerenrot / berry (19)



ART.-NR. MODEL	GRÖSSE CA. Ø SIZE APPR.	HÖHE CA. HEIGHT APPR.	INHALT CA. VOLUME APPR.	VE PU
450 014 19	14	13,0	1,2	5
450 016 19	16	14,5	1,9	5
450 019 19	19	17,5	3,3	5
450 023 19	23	21,0	6,0	5
450 030 19	30	27,0	14,0	5
450 040 19	40	36,0	32,0	5

 pistazie / pistachio (20)



ART.-NR. MODEL	GRÖSSE CA. Ø SIZE APPR.	HÖHE CA. HEIGHT APPR.	INHALT CA. VOLUME APPR.	VE PU
450 014 20	14	13,0	1,2	5
450 016 20	16	14,5	1,9	5
450 019 20	19	17,5	3,3	5
450 023 20	23	21,0	6,0	5
450 030 20	30	27,0	14,0	5
450 040 20	40	36,0	32,0	5

 anthrazit / anthracite (38)



ART.-NR. MODEL	GRÖSSE CA. Ø SIZE APPR.	HÖHE CA. HEIGHT APPR.	INHALT CA. VOLUME APPR.	VE PU
450 014 38	14	13,0	1,2	5
450 016 38	16	14,5	1,9	5
450 019 38	19	17,5	3,3	5
450 023 38	23	21,0	6,0	5
450 030 38	30	27,0	14,0	5
450 040 38	40	36,0	32,0	5

 hellgrau / light grey (60)



ART.-NR. MODEL	GRÖSSE CA. Ø SIZE APPR.	HÖHE CA. HEIGHT APPR.	INHALT CA. VOLUME APPR.	VE PU
450 014 60	14	13,0	1,2	5
450 016 60	16	14,5	1,9	5
450 019 60	19	17,5	3,3	5
450 023 60	23	21,0	6,0	5
450 030 60	30	27,0	14,0	5
450 040 60	40	36,0	32,0	5

Alle Maße in cm, Volumen in Liter / all sizes in cm, volume in litres
*Farbe 10 ausgenommen / colour no. 10 excluded



TUBO

ÜBERTOPF
CACHEPOT



NEW

TUBO ÜBERTOPF TUBO CACHEPOT



○ weiß / white (10)

ART.-NR. MODEL	GRÖSSE CA. Ø SIZE APPR.	HÖHE CA. HEIGHT APPR.	INHALT CA. VOLUME APPR.	VE PU
488 013 10	12,8	11,3	1,2	10
488 015 10	14,8	13,0	1,8	10
488 018 10	17,8	15,7	3,2	10
488 020 10	19,9	17,7	4,6	10
488 024 10	23,9	21,0	8	5
488 030 10	29,2	25,7	14,5	5



● dunkelgrün / dark green (11)

ART.-NR. MODEL	GRÖSSE CA. Ø SIZE APPR.	HÖHE CA. HEIGHT APPR.	INHALT CA. VOLUME APPR.	VE PU
488 013 11	12,8	11,3	1,2	10
488 015 11	14,8	13,0	1,8	10
488 018 11	17,8	15,7	3,2	10
488 020 11	19,9	17,7	4,6	10
488 024 11	23,9	21,0	8	5
488 030 11	29,2	25,7	14,5	5



● anthrazit / anthracite (38)

ART.-NR. MODEL	GRÖSSE CA. Ø SIZE APPR.	HÖHE CA. HEIGHT APPR.	INHALT CA. VOLUME APPR.	VE PU
488 013 38	12,8	11,3	1,2	10
488 015 38	14,8	13,0	1,8	10
488 018 38	17,8	15,7	3,2	10
488 020 38	19,9	17,7	4,6	10
488 024 38	23,9	21,0	8	5
488 030 38	29,2	25,7	14,5	5



○ betonfarbe / concrete colour (59)

ART.-NR. MODEL	GRÖSSE CA. Ø SIZE APPR.	HÖHE CA. HEIGHT APPR.	INHALT CA. VOLUME APPR.	VE PU
488 013 59	12,8	11,3	1,2	10
488 015 59	14,8	13,0	1,8	10
488 018 59	17,8	15,7	3,2	10
488 020 59	19,9	17,7	4,6	10
488 024 59	23,9	21,0	8	5
488 030 59	29,2	25,7	14,5	5





MILLY

ÜBERTOPF
CACHEPOT

MILLY ÜBERTOPF MILLY CACHEPOT



○ weiß / white (10)

ART.-NR. MODEL	GRÖSSE CA. Ø SIZE APPR.	HÖHE CA. HEIGHT APPR.	INHALT CA. VOLUME APPR.	VE PU
487 013 10	12,9	11,4	1,2	10
487 015 10	14,6	12,9	1,7	10
487 017 10	16,9	14,9	2,7	10
487 020 10	19,6	17,3	4	10
487 024 10	23,6	20,8	7	5
487 030 10	29,2	25,8	13,5	5



● dunkelgrün / dark green (11)

ART.-NR. MODEL	GRÖSSE CA. Ø SIZE APPR.	HÖHE CA. HEIGHT APPR.	INHALT CA. VOLUME APPR.	VE PU
487 013 11	12,9	11,4	1,2	10
487 015 11	14,6	12,9	1,7	10
487 017 11	16,9	14,9	2,7	10
487 020 11	19,6	17,3	4	10
487 024 11	23,6	20,8	7	5
487 030 11	29,2	25,8	13,5	5



● anthrazit / anthracite (38)

ART.-NR. MODEL	GRÖSSE CA. Ø SIZE APPR.	HÖHE CA. HEIGHT APPR.	INHALT CA. VOLUME APPR.	VE PU
487 013 38	12,9	11,4	1,2	10
487 015 38	14,6	12,9	1,7	10
487 017 38	16,9	14,9	2,7	10
487 020 38	19,6	17,3	4	10
487 024 38	23,6	20,8	7	5
487 030 38	29,2	25,8	13,5	5



○ betonfarbe / concrete colour (59)

ART.-NR. MODEL	GRÖSSE CA. Ø SIZE APPR.	HÖHE CA. HEIGHT APPR.	INHALT CA. VOLUME APPR.	VE PU
487 013 59	12,9	11,4	1,2	10
487 015 59	14,6	12,9	1,7	10
487 017 59	16,9	14,9	2,7	10
487 020 59	19,6	17,3	4	10
487 024 59	23,6	20,8	7	5
487 030 59	29,2	25,8	13,5	5



CASABLANCA

ÜBERTOPF
CACHEPOT



CASABLANCA ÜBERTOPF GLÄNZEND CASABLANCA CACHEPOT SHINY



● anthrazit metallic /
anthracite metallic (62)

ART.-NR. MODEL	GRÖSSE CA. Ø SIZE APPR.	HÖHE CA. HEIGHT APPR.	INHALT CA. VOLUME APPR.	VE PU
483 012 62	12,5	11,0	0,7	10
483 014 62	14,5	13,0	1,5	10
483 016 62	16,5	15,0	2,0	10
483 018 62	19,0	16,5	3,0	10
483 020 62	20,5	18,5	3,5	10
483 025 62	26,0	23,0	7,5	5
483 030 62	31,0	28,0	14,0	5
483 035 62	36,0	32,5	20,5	5



● silber metallic /
silver metallic (63)

ART.-NR. MODEL	GRÖSSE CA. Ø SIZE APPR.	HÖHE CA. HEIGHT APPR.	INHALT CA. VOLUME APPR.	VE PU
483 012 63	12,5	11,0	0,7	10
483 014 63	14,5	13,0	1,5	10
483 016 63	16,5	15,0	2,0	10
483 018 63	19,0	16,5	3,0	10
483 020 63	20,5	18,5	3,5	10
483 025 63	26,0	23,0	7,5	5
483 030 63	31,0	28,0	14,0	5
483 035 63	36,0	32,5	20,5	5





PURE

ÜBERTOPF
CACHEPOT

PURE ÜBERTOPF
PURE CACHEPOT



SEITE 219
PAGE



● creme / creme (35)

ART.-NR. MODEL	GRÖSSE CA. Ø SIZE APPR.	HÖHE CA. HEIGHT APPR.	INHALT CA. VOLUME APPR.	VE PU
481 011 35	11	9,5	0,65	10
481 013 35	13	11,5	1,10	10
481 015 35	15	13,0	1,60	10
481 018 35	18	15,5	2,80	10
481 021 35	21	18,0	4,50	10
481 025 35	25	21,5	7,80	10



● anthrazit / anthracite (38)

ART.-NR. MODEL	GRÖSSE CA. Ø SIZE APPR.	HÖHE CA. HEIGHT APPR.	INHALT CA. VOLUME APPR.	VE PU
481 011 38	11	9,5	0,65	10
481 013 38	13	11,5	1,10	10
481 015 38	15	13,0	1,60	10
481 018 38	18	15,5	2,80	10
481 021 38	21	18,0	4,50	10
481 025 38	25	21,5	7,80	10



ORCHIDEENTOPF

ORCHID POT



ORCHIDEENTOPF TRANSPARENT

ORCHID POT TRANSPARENT



transparent klar /
transparent clear (70)

ART.-NR. MODEL	GRÖSSE CA. Ø SIZE APPR.	HÖHE CA. HEIGHT APPR.	INHALT CA. VOLUME APPR.	VE PU
340 012 70	12	11	0,7	20
340 015 70	15	14	1,7	20
340 017 70	17	16	2,4	10
340 019 70	19	17	3,5	10

ORCHIDEEN-KULTURTOPF TRANSPARENT

ORCHID CULTURE POT TRANSPARENT



transparent milchig /
transparent opaque (71)

ART.-NR. MODEL	GRÖSSE CA. Ø SIZE APPR.	HÖHE CA. HEIGHT APPR.	INHALT CA. VOLUME APPR.	VE PU
341 012 71	12	11	0,5	10
341 014 71	14	12	0,8	10
341 016 71	16	13	1,2	10

ZUBEHÖR
ACCESSORIES

UNTERSETZER FÜR ORCHIDEENTOPF

SAUCER FOR ORCHID POT

SEITE 210
PAGE



ART.-NR. PFLANZTOPF MODEL PLANTER	ART.-NR. UNTERSETZER MODEL SAUCER
340 012 70	808 012 70
340 015 70	808 014 70
340 017 70	808 016 70
340 019 70	808 021 70

ZUBEHÖR
ACCESSORIES

ORCHIDEENSTÄBE IM DISPLAY

ORCHID RODS IN DISPLAY

SEITE 211
PAGE





Outdoor

Übersicht / Overview

Blumenkästen _____	56
Flower boxes	
Blumenkästen mit Bewässerungssystem _____	64
Self-watering flower boxes	
Urban Gardening _____	84
Urban Gardening	
Pflanzgefäße _____	94
Planters	
Pflanzgefäße Serie Kubus _____	128
Planters Kubus range	
Pflanzgefäße Serie Rillen _____	136
Planters Rillen range	
Pflanzgefäße Serie Stone _____	148
Planters Stone range	
Pflanzgefäße Serie Napoli _____	156
Planters Napoli range	
Pflanzgefäße Serie Rimini _____	162
Planters Rimini range	
Pflanzgefäße Naturdesign _____	168
Planters Nature design	

Blumenkästen

Flower boxes



UNSERE BLUMENKÄSTEN /
OUR FLOWER BOXES:



STANDARD BLUMENKASTEN
STANDARD FLOWER BOX



Seite / Page 58



TOSCANA BLUMENKASTEN
TOSCANA FLOWER BOX



Seite / Page 60



BERGAMO BLUMENKASTEN
BERGAMO FLOWER BOX



Seite / Page 62

PRODUKTE AUF DIESER SEITE / PRODUCTS ON THIS PAGE:
STANDARD Blumenkasten in terracotta und anthrazit /
STANDARD Flower box in terracotta and anthracite

STANDARD

BLUMENKASTEN MIT HOLZSTRUKTUR
FLOWER BOX WITH WOOD STRUCTURE



ZUBEHÖR
ACCESSORIES

PRODUKT PRODUCT	TYP TYPE	ART.-NR. MODEL	SEITE PAGE
Blumenkasten-Halter Flower box brackets	UNIVERSAL	39 816 000 ..	197
Blumenkasten-Halter Flower box brackets	B	39 811 000 ..	198
Blumenkasten-Halter Flower box brackets	C	39 813 000 ..	198
Blumenkasten-Halter Flower box brackets	D	39 817 000 ..	199
Blumenkasten-Halter Flower box brackets	G (4,5 cm Ø)	39 819 001 42	197
Blumenkasten-Halter Flower box brackets	H	39 812 000 ..	199
Blumenkasten-Untersetzer Flower box saucers		804 ...	193



VERSTÄRKUNGSSTREBE
REINFORCEMENT STRUT

ART.-NR. 900 803 99
MODEL

SEITE 213
PAGE



**STANDARD BLUMENKASTEN
MIT HOLZSTRUKTUR**
STANDARD FLOWER BOX
WITH WOOD STRUCTURE



SEITE 220
PAGE

● terracotta / terracotta (06)



ART.-NR. MODEL	LxBxH CA. LxWxH APPR.	INHALT CA. VOLUME APPR.	VE PU
803 040 06	40x17,5x14,5	6,5	10
803 050 06	50x17,5x14,5	7,5	10
803 060 06	60x17,5x14,5	9,5	10
803 080 06	80x17,5x14,5	13,5	10
803 100 06	100x17,5x14,5	16,5	10

● braun / brown (08)



ART.-NR. MODEL	LxBxH CA. LxWxH APPR.	INHALT CA. VOLUME APPR.	VE PU
803 040 08	40x17,5x14,5	6,5	10
803 050 08	50x17,5x14,5	7,5	10
803 060 08	60x17,5x14,5	9,5	10
803 080 08	80x17,5x14,5	13,5	10
803 100 08	100x17,5x14,5	16,5	10

○ weiß / white (10)



ART.-NR. MODEL	LxBxH CA. LxWxH APPR.	INHALT CA. VOLUME APPR.	VE PU
803 040 10	40x17,5x14,5	6,5	10
803 050 10	50x17,5x14,5	7,5	10
803 060 10	60x17,5x14,5	9,5	10
803 080 10	80x17,5x14,5	13,5	10
803 100 10	100x17,5x14,5	16,5	10

● dunkelgrün / dark green (11)



ART.-NR. MODEL	LxBxH CA. LxWxH APPR.	INHALT CA. VOLUME APPR.	VE PU
803 040 11	40x17,5x14,5	6,5	10
803 050 11	50x17,5x14,5	7,5	10
803 060 11	60x17,5x14,5	9,5	10
803 080 11	80x17,5x14,5	13,5	10
803 100 11	100x17,5x14,5	16,5	10

● pistazie / pistachio (20)



ART.-NR. MODEL	LxBxH CA. LxWxH APPR.	INHALT CA. VOLUME APPR.	VE PU
-	-	-	-
-	-	-	-
803 060 20	60x17,5x14,5	9,5	10
803 080 20	80x17,5x14,5	13,5	10
803 100 20	100x17,5x14,5	16,5	10

● anthrazit / anthracite (38)



ART.-NR. MODEL	LxBxH CA. LxWxH APPR.	INHALT CA. VOLUME APPR.	VE PU
803 040 38	40x17,5x14,5	6,5	10
803 050 38	50x17,5x14,5	7,5	10
803 060 38	60x17,5x14,5	9,5	10
803 080 38	80x17,5x14,5	13,5	10
803 100 38	100x17,5x14,5	16,5	10

○ betonfarbe /
concrete colour (59)



ART.-NR. MODEL	LxBxH CA. LxWxH APPR.	INHALT CA. VOLUME APPR.	VE PU
803 040 59	40x17,5x14,5	6,5	10
-	-	-	-
803 060 59	60x17,5x14,5	9,5	10
803 080 59	80x17,5x14,5	13,5	10
803 100 59	100x17,5x14,5	16,5	10

*Farbe 10 ausgenommen / colour no. 10 excluded

TOSCANA

BLUMENKASTEN FLOWER BOX



TOSCANA BLUMENKASTEN TOSCANA FLOWER BOX



● terracotta / terracotta (06)

ART.-NR. MODEL	LxBxH CA. LxWxH APPR.	INHALT CA. VOLUME APPR.	VE PU
822 060 06	60x19,5x16	11	10
822 080 06	80x19,5x16	15	10
822 100 06	100x19,5x16	19	10



● anthrazit / anthracite (38)

ART.-NR. MODEL	LxBxH CA. LxWxH APPR.	INHALT CA. VOLUME APPR.	VE PU
822 060 38	60x19,5x16	11	10
822 080 38	80x19,5x16	15	10
822 100 38	100x19,5x16	19	10

ZUBEHÖR
ACCESSORIES

PRODUKT PRODUCT	TYP TYPE	ART.-NR. MODEL	SEITE PAGE
Blumenkasten-Halter Flower box brackets	UNIVERSAL	39 816 000 ..	197
Blumenkasten-Halter Flower box brackets	F	39 815 000 ..	199
Blumenkasten-Halter Flower box brackets	H	39 812 000 ..	199
Blumenkasten-Untersetzer Flower box saucers		842 ...	194

ERSATZTEIL
SPARE PART

VERSTÄRKUNGSSTREBE
REINFORCEMENT STRUT

ART.-NR. 900 825 99
MODEL
SEITE 213
PAGE





BERGAMO

BLUMENKASTEN
FLOWER BOX

BERGAMO BLUMENKASTEN BERGAMO FLOWER BOX



● impruneta / impruneta (37)

ART.-NR. MODEL	AUSSENMASS CA. OUTSIDE DIMENSION APPR.	HÖHE CA. HEIGHT APPR.	INNENMASS CA. INSIDE DIMENSION APPR.	BODENMASS CA. GROUND DIMENSION APPR.	INHALT CA. VOLUME APPR.	VE PU
114 080 37	80x20	18	74x14	72x12	16,5	1



Bewässerungsblumenkästen

Self-watering flower boxes



BLUMENKÄSTEN MIT BEWÄSSERUNGSSYSTEM / SELF-WATERING FLOWER BOXES:



VIVA

Seite / Page 66



NEO-LINE

Seite / Page 68

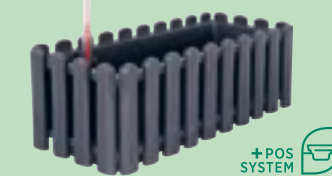

AQUA PALIDO

Seite / Page 70



AQUA GREEN

Seite / Page 72



AQUA TOSCANA

Seite / Page 74



AQUA ANDALUCIA

Seite / Page 76



AQUA ANDALUCIA BEEDABEI

Seite / Page 78



AQUA FLOR

Seite / Page 80



MAYA

Seite / Page 82

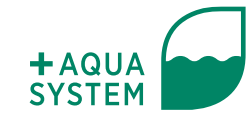

Unsere Blumenkästen mit Bewässerungssystem

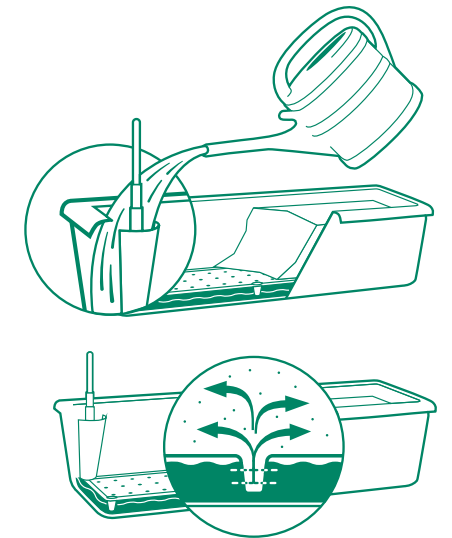

- Bewährtes System
- Großer Wasservorrat
- Wasserversorgung über erdgefüllte Kegel
- Einfüllstutzen mit Wasserstandsanzeiger
- Überlauföffnungen im Wasserspeicher (überschüssiges Wasser – durch zu starkes Gießen oder Regen verursacht – kann ablaufen, dadurch kein Übernässen der Erde)
- Leichtes Herausnehmen des Zwischenbodens zur Reinigung
- Verbindung aller Teile durch Klick-System
- Verstärkungsstrebe für bessere Stabilität (an den Blumenkästen 80 cm und 100 cm)
- Gute Stapelfähigkeit – platzsparende Lagerung
- Passende Halterungen und Untersetzer im Sortiment verfügbar (separat erhältlich)

SELF-WATERING FLOWER BOX

- Tried and Tested System
- Large water storage
- Water supply via earth-filled cones
- Filler pipe with water level indicator
- Overflow openings in the water reservoir (excess water – caused by rain or watering too much – can drain, preventing the soil from becoming too wet)
- False floor can be removed easily for cleaning
- All parts are connected with a click system
- Reinforcement strut for better stability (on flower boxes 80 cm and 100 cm)
- Good stacking capability – space-saving storage
- Matching brackets and saucers also available (sold separately)

PRODUKT AUF DIESER SEITE / PRODUCT ON THIS PAGE:
 VIVA Bewässerungsblumenkasten in betonfarbe /
 VIVA Self-watering flower box in concrete colour



VIVA

BLUMENKASTEN MIT BEWÄSSERUNGSSYSTEM SELF-WATERING FLOWER BOX

NEW

VIVA BEWÄSSERUNGSBLUMENKASTEN MIT WASSERSTANDSANZEIGER VIVA SELF-WATERING FLOWER BOX INCL. WATER LEVEL INDICATOR

RECYCLED PLASTICS
 + AQUA SYSTEM
 + POS SYSTEM

SEITE 221
PAGE



● terracotta / terracotta (06)

ART.-NR. MODEL	LÄNGE CA. LENGTH APPR.	BREITE CA. WIDTH APPR.	HÖHE CA. HEIGHT APPR.	VE PU
820 040 06	40	21,2	17,1	5
820 060 06	60	21,2	17,1	5
820 080 06	80	21,2	17,1	5
820 100 06	100	21,2	17,1	5

○ weiß / white (10)

ART.-NR. MODEL	LÄNGE CA. LENGTH APPR.	BREITE CA. WIDTH APPR.	HÖHE CA. HEIGHT APPR.	VE PU
820 040 10	40	21,2	17,1	5
820 060 10	60	21,2	17,1	5
820 080 10	80	21,2	17,1	5
820 100 10	100	21,2	17,1	5



● anthrazit / anthracite (38)

ART.-NR. MODEL	LÄNGE CA. LENGTH APPR.	BREITE CA. WIDTH APPR.	HÖHE CA. HEIGHT APPR.	VE PU
820 040 38	40	21,2	17,1	5
820 060 38	60	21,2	17,1	5
820 080 38	80	21,2	17,1	5
820 100 38	100	21,2	17,1	5

○ betonfarbe / concrete colour (59)

ART.-NR. MODEL	LÄNGE CA. LENGTH APPR.	BREITE CA. WIDTH APPR.	HÖHE CA. HEIGHT APPR.	VE PU
820 040 59	40	21,2	17,1	5
820 060 59	60	21,2	17,1	5
820 080 59	80	21,2	17,1	5
820 100 59	100	21,2	17,1	5

i PFLANZGESTELL (PASSEND ZUM KASTEN MIT 60 CM LÄNGE) MUSS SEPARAT ERWORBEN WERDEN.
THE PLANT STAND (SUITABLE FOR THE 60CM FLOWER BOX) HAS TO BE PURCHASED SEPARATELY.

PFLANZGESTELL FÜR VIVA BLUMENKASTEN 60 CM PLANT STAND FOR VIVA FLOWER BOX 60 CM



● schwarz / black

ART.-NR. MODEL	AUSSENMASS CA. OUTSIDE DIM. APPR.	HÖHE CA. HEIGHT APPR.	BODENMASS CA. GROUND DIM. APPR.	VE PU
100 820 60	57,3x19,8	19	63,5x26,0	5

i LIEFERUMFANG: BEWÄSSERUNGSEINSATZ, WASSERSTANDSANZEIGER, VERSTÄRKUNGSSTREBE
INCLUDED IN DELIVERY: WATERING SYSTEM, WATER LEVEL INDICATOR, REINFORCEMENT STRUT

WEITERE INFORMATIONEN FURTHER DETAILS

ERDVOLUMEN CA. SOIL VOLUME APPR.
WASSERINHALT CA. WATER-VOLUME APPR.
LÄNGE / LENGTH

ZUBEHÖR ACCESSORIES

PRODUKT PRODUCT	TYP TYPE	ART.-NR. MODEL	SEITE PAGE
Blumenkasten-Halter Flower box brackets	UNIVERSAL	39 816 000 ..	197
Blumenkasten-Halter Flower box brackets	A	39 818 000 ..	198

ERSATZTEIL SPARE PART

PRODUKT PRODUCT	ART.-NR. MODEL	SEITE PAGE
Wasserstandsanzeiger Water level indicator	900 802 08	213
Bewässerungseinsatz Watering system	900 820 ..	213

NEO-LINE

BLUMENKASTEN
MIT BEWÄSSERUNGSSYSTEM
SELF-WATERING FLOWER BOX



NEO-LINE
BEWÄSSERUNGSBLUMENKASTEN MIT WASSERSTANDSANZEIGER
NEO-LINE SELF-WATERING FLOWER BOX INCL. WATER LEVEL INDICATOR



● anthrazit /
anthracite (38)

ART.-NR. MODEL	LÄNGE CA. LENGTH APPR.	BREITE CA. WIDTH APPR.	HÖHE CA. HEIGHT APPR.	VE PU
829 050 38	50	18	18	5
829 075 38	75	18	18	5



● betonfarbe /
concrete colour (59)

ART.-NR. MODEL	LÄNGE CA. LENGTH APPR.	BREITE CA. WIDTH APPR.	HÖHE CA. HEIGHT APPR.	VE PU
829 050 59	50	18	18	5
829 075 59	75	18	18	5



LIEFERUMFANG:
BEWÄSSERUNGSEINSATZ,
WASSERSTANDSANZEIGER,
VERSTÄRKUNGSSTREBE
INCLUDED IN DELIVERY: WATERING SYSTEM,
WATER LEVEL INDICATOR, REINFORCEMENT
STRUT

WEITERE INFORMATIONEN
FURTHER DETAILS

ERDVOLUMEN CA.
SOIL VOLUME APPR.
WASSERINHALT CA.
WATER-VOLUME APPR.
LÄNGE / LENGTH

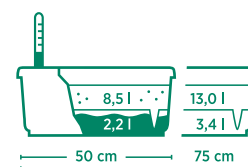

ZUBEHÖR ACCESSORIES

PRODUKT PRODUCT	TYP TYPE	ART.-NR. MODEL	SEITE PAGE
Blumenkasten-Halter Flower box brackets	UNIVERSAL	39 816 000 ..	197
Blumenkasten-Halter Flower box brackets	A	39 818 000 ..	198

ERSATZTEIL SPARE PART

PRODUKT PRODUCT	ART.-NR. MODEL	SEITE PAGE
Wasserstandsanzeiger Water level indicator	900 802 08	213
Verstärkungsstrebe Reinforcement strut	900 829 99	213
Bewässerungseinsatz Watering system	900 829 ..	213





AQUA PALIDO

BLUMENKASTEN MIT BEWÄSSERUNGSSYSTEM
SELF-WATERING FLOWER BOX



LIEFERUMFANG:
BEWÄSSERUNGSEINSATZ,
WASSERSTANDSANZEIGER,
VERSTÄRKUNGSTREBE
INCLUDED IN DELIVERY: WATERING SYSTEM,
WATER LEVEL INDICATOR, REINFORCEMENT
STRUT

WEITERE INFORMATIONEN FURTHER DETAILS

ERDVOLUMEN CA.
SOIL VOLUME APPR.
WASSERINHALT CA.
WATER-VOLUME APPR.
LÄNGE / LENGTH

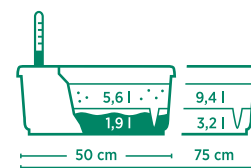

AQUA PALIDO BEWÄSSERUNGSBLUMENKASTEN MIT WASSERSTANDSANZEIGER AQUA PALIDO SELF-WATERING FLOWER BOX INCL. WATER LEVEL INDICATOR



SEITE 223
PAGE

○ weiß / white (10)



ART.-NR. MODEL	LÄNGE CA. LENGTH APPR.	BREITE CA. WIDTH APPR.	HÖHE CA. HEIGHT APPR.	VE PU
831 050 10	47	19,5	17	1
831 075 10	74	19,5	17	1

● anthrazit /
anthracite (38)



ART.-NR. MODEL	LÄNGE CA. LENGTH APPR.	BREITE CA. WIDTH APPR.	HÖHE CA. HEIGHT APPR.	VE PU
831 050 38	47	19,5	17	1
831 075 38	74	19,5	17	1

○ zartrosa /
soft pink (86)



ART.-NR. MODEL	LÄNGE CA. LENGTH APPR.	BREITE CA. WIDTH APPR.	HÖHE CA. HEIGHT APPR.	VE PU
831 050 86	47	19,5	17	1
831 075 86	74	19,5	17	1



ZUBEHÖR ACCESSORIES

PRODUKT PRODUCT	TYP TYPE	ART.-NR. MODEL	SEITE PAGE
Blumenkasten-Halter Flower box brackets	UNIVERSAL	39 816 000 ..	197
Blumenkasten-Halter Flower box brackets	A	39 818 000 ..	198



ERSATZTEIL SPARE PART

PRODUKT PRODUCT	ART.-NR. MODEL	SEITE PAGE
Wasserstandsanzeiger Water level indicator	900 802 08	213
Bewässerungseinsatz Watering system	900 830 ..	213



AQUA GREEN

BLUMENKASTEN MIT BEWÄSSERUNGSSYSTEM
SELF-WATERING FLOWER BOX



LIEFERUMFANG:
BEWÄSSERUNGSEINSATZ,
WASSERSTANDSANZEIGER,
VERSTÄRKUNGSSTREBE
INCLUDED IN DELIVERY: WATERING SYSTEM,
WATER LEVEL INDICATOR, REINFORCEMENT
STRUT

ZUBEHÖR
ACCESSORIES

PRODUKT PRODUCT	TYP TYPE	ART.-NR. MODEL	SEITE PAGE
Blumenkasten-Halter Flower box brackets	UNIVERSAL	39 816 000 ..	197
Blumenkasten-Halter Flower box brackets	A	39 818 000 ..	198
Blumenkasten-Halter Flower box brackets	E	39 814 000 ..	199
Blumenkasten-Halter Flower box brackets	G (6,5 cm Ø)	39 819 002 42	197
Blumenkasten-Untersetzer Flower box saucers		844 ...	195



ERSATZTEIL
SPARE PART

PRODUKT PRODUCT	ART.-NR. MODEL	SEITE PAGE
Wasserstandsanzeiger Water level indicator	900 802 08	213
Verstärkungsstrebe Reinforcement strut	900 837 99	213
Bewässerungseinsatz Watering system	900 820 ..	213

AQUA GREEN
BEWÄSSERUNGSBLUMENKASTEN MIT WASSERSTANDSANZEIGER
AQUA GREEN SELF-WATERING FLOWER BOX INCL. WATER LEVEL INDICATOR

RECYCLED
PLASTICS

+ AQUA
SYSTEM

+ POS
SYSTEM

SEITE 223
PAGE

● terracotta / terracotta (06)



ART.-NR. MODEL	LxBxH CA. LxWxH APPR.	VE PU	EUROPALETTE** EURO PALLET*
837 060 06	60x21x17,5	5	120
837 080 06	80x21x17,5	5	90
837 100 06	100x21x17,5	5	60

● braun / brown (08)



ART.-NR. MODEL	LxBxH CA. LxWxH APPR.	VE PU	EUROPALETTE** EURO PALLET*
837 060 08	60x21x17,5	5	120
837 080 08	80x21x17,5	5	90
837 100 08	100x21x17,5	5	60

○ weiß / white (10)

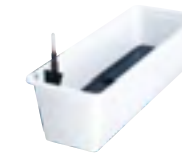

ART.-NR. MODEL	LxBxH CA. LxWxH APPR.	VE PU	EUROPALETTE** EURO PALLET*
837 060 10	60x21x17,5	5	120
837 080 10	80x21x17,5	5	90
837 100 10	100x21x17,5	5	60

● dunkelgrün / dark green (11)



ART.-NR. MODEL	LxBxH CA. LxWxH APPR.	VE PU	EUROPALETTE** EURO PALLET*
837 060 11	60x21x17,5	5	120
837 080 11	80x21x17,5	5	90
837 100 11	100x21x17,5	5	60

● anthrazit / anthracite (38)



ART.-NR. MODEL	LxBxH CA. LxWxH APPR.	VE PU	EUROPALETTE** EURO PALLET*
837 060 38	60x21x17,5	5	120
837 080 38	80x21x17,5	5	90
837 100 38	100x21x17,5	5	60

WEITERE INFORMATIONEN
FURTHER DETAILS

ERDVOLUMEN CA.
SOIL VOLUME APPR.
WASSERINHALT CA.
WATER-VOLUME APPR.
LÄNGE / LENGTH

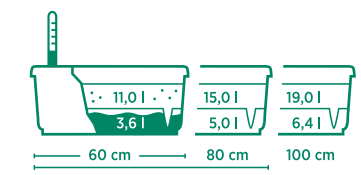

AQUA TOSCANA

BLUMENKASTEN MIT BEWÄSSERUNGSSYSTEM
SELF-WATERING FLOWER BOX



AQUA TOSCANA BEWÄSSERUNGSBLUMENKASTEN MIT WASSERSTANDSANZEIGER AQUA TOSCANA SELF-WATERING FLOWER BOX INCL. WATER LEVEL INDICATOR



SEITE 224
PAGE



● terracotta /
terracotta (06)

ART.-NR. MODEL	LÄNGE CA. LENGTH APPR.	BREITE CA. WIDTH APPR.	HÖHE CA. HEIGHT APPR.	VE PU
825 060 06	60	19,5	16	5
825 080 06	80	19,5	16	5
825 100 06	100	19,5	16	5



● anthrazit /
anthracite (38)

ART.-NR. MODEL	LÄNGE CA. LENGTH APPR.	BREITE CA. WIDTH APPR.	HÖHE CA. HEIGHT APPR.	VE PU
825 060 38	60	19,5	16	5
825 080 38	80	19,5	16	5
825 100 38	100	19,5	16	5



LIEFERUMFANG:
BEWÄSSERUNGSEINSATZ,
WASSERSTANDSANZEIGER,
VERSTÄRKUNGSSTREBE
INCLUDED IN DELIVERY: WATERING SYSTEM,
WATER LEVEL INDICATOR, REINFORCEMENT
STRUT



BLUMENKASTEN-
HALTERUNG AUF
DER VORDERSEITE
NICHT SICHTBAR.
FLOWER BOX BRACKETS
NOT VISIBLE FROM
THE FRONT.

ZUBEHÖR
ACCESSORIES

PRODUKT PRODUCT	TYP TYPE	ART.-NR. MODEL	SEITE PAGE
Blumenkasten-Halter Flower box brackets	UNIVERSAL	39 816 000 ..	197
Blumenkasten-Halter Flower box brackets	F	39 815 000 ..	199
Blumenkasten-Halter Flower box brackets	H	39 812 000 ..	199
Blumenkasten-Halter Flower box brackets	G (6,5 cm Ø)	39 819 002 42	197
Blumenkasten-Untersetzer Flower box saucers		842 ...	194



ERSATZTEIL
SPARE PART

PRODUKT PRODUCT	ART.-NR. MODEL	SEITE PAGE
Wasserstandsanzeiger Water level indicator	900 802 08	213
Verstärkungsstrebe Reinforcement strut	900 825 99	213
Bewässerungseinsatz Watering system	900 825 ..	213

WEITERE INFORMATIONEN
FURTHER DETAILS

ERDVOLUMEN CA.
SOIL VOLUME APPR.
WASSERINHALT CA.
WATER-VOLUME APPR.
LÄNGE / LENGTH

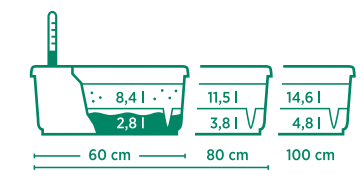

AQUA ANDALUCIA

BLUMENKASTEN MIT BEWÄSSERUNGSSYSTEM
SELF-WATERING FLOWER BOX



STRUKTUR

Oberfläche in Terracottastruktur
Terracotta textured surface



ZUBEHÖR
ACCESSORIES

PRODUKT PRODUCT	TYP TYPE	ART.-NR. MODEL	SEITE PAGE
Blumenkasten-Halter Flower box brackets	UNIVERSAL	39 816 000 ..	197
Blumenkasten-Halter Flower box brackets	A	39 818 000 ..	198
Blumenkasten-Halter Flower box brackets	E	39 814 000 ..	199
Blumenkasten-Untersetzer Flower box saucers		844 ...	195



**LIEFERUMFANG:
BEWÄSSERUNGSEINSATZ,
WASSERSTANDSANZEIGER,
VERSTÄRKUNGSSTREBE**
INCLUDED IN DELIVERY: WATERING SYSTEM,
WATER LEVEL INDICATOR, REINFORCEMENT
STRUT

AQUA ANDALUCIA BEWÄSSERUNGSBLUMENKASTEN MIT WASSERSTANDSANZEIGER AQUA ANDALUCIA SELF-WATERING FLOWER BOX INCL. WATER LEVEL INDICATOR

RECYCLED
PLASTICS

+ AQUA
SYSTEM

+ POS
SYSTEM

SEITE 225
PAGE

● terracotta / terracotta (06)



ART.-NR. MODEL	LxBxH CA. LxWxH APPR.	VE PU	EUROPALETTE** EURO PALLET**
828 060 06	60x23x18	5	100
828 080 06	80x23x18	5	75
828 100 06	100x23x18	5	50

● braun / brown (08)



ART.-NR. MODEL	LxBxH CA. LxWxH APPR.	VE PU	EUROPALETTE** EURO PALLET**
828 060 08	60x23x18	5	100
828 080 08	80x23x18	5	75
828 100 08	100x23x18	5	50

○ weiß / white (10)



ART.-NR. MODEL	LxBxH CA. LxWxH APPR.	VE PU	EUROPALETTE** EURO PALLET**
828 060 10	60x23x18	5	100
828 080 10	80x23x18	5	75
828 100 10	100x23x18	5	50

● anthrazit / anthracite (38)



ART.-NR. MODEL	LxBxH CA. LxWxH APPR.	VE PU	EUROPALETTE** EURO PALLET**
828 060 38	60x23x18	5	100
828 080 38	80x23x18	5	75
828 100 38	100x23x18	5	50



ERSATZTEIL
SPARE PART

PRODUKT PRODUCT	ART.-NR. MODEL	SEITE PAGE
Wasserstandsanzeiger Water level indicator	900 802 08	213
Verstärkungsstrebe Reinforcement strut	900 837 99	213
Bewässerungseinsatz Watering system	900 820 ..	213

WEITERE INFORMATIONEN FURTHER DETAILS

ERDVOLUMEN CA.
SOIL VOLUME APPR.
WASSERINHALT CA.
WATER-VOLUME APPR.
LÄNGE / LENGTH

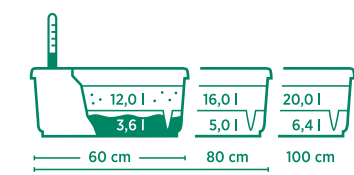

AQUA ANDALUCIA BEEDABEI



Geli ist dabei! Geli is there!

Umweltschutz hört für uns nicht vor den Toren unseres Unternehmens auf. Deswegen macht es uns stolz, seit 2019 zum Erfolg des Projekts „Beedabei“ beizutragen, das unter dem Motto „Bienen dabei – sei dabei!“ ins Leben gerufen wurde. Seien auch Sie dabei!

Mehr zum Projekt unter www.beedabei.de

For us, protecting the environment doesn't end at the gates to our facilities. And that's why we're so proud of the fact that we've been contributing to the success of the 'Beedabei' project since 2019, which was launched with the motto 'Bienen dabei – sei dabei' ('bees there – be there'). Be there too!

More about the project at www.beedabei.de



Der Erlös kommt dem Projekt zugute.
The proceeds benefit the project.

WEITERE INFORMATIONEN FURTHER DETAILS

ERDVOLUMEN CA.
SOIL VOLUME APPR.
WASSERINHALT CA.
WATER-VOLUME APPR.
LÄNGE / LENGTH

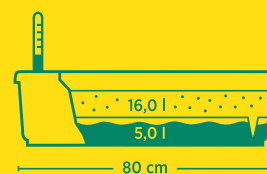

**AQUA ANDALUCIA BEEDABEI
BEWÄSSERUNGSBLUMENKASTEN MIT WASSERSTANDSANZEIGER**
AQUA ANDALUCIA BEEDABEI SELF-WATERING FLOWER BOX INCL. WATER LEVEL INDICATOR



i LIEFERUMFANG UND ALLE ZUBEHÖR- UND ERSATZTEILE SIND IDENTISCH MIT DEM AQUA ANDALUCIA.
WHAT IS INCLUDED IN THE DELIVERY AND ALL THE ACCESSORIES AND SPARE PARTS ARE IDENTICAL TO THE AQUA ANDALUCIA.



● gelb / yellow (02)

ART.-NR. MODEL	LxBxH CA. LxWxH APPR.	VE PU	EUROPALETTE* EURO PALLET*
828 080 02	80x23x18	5	75



AQUA FLOR

BLUMENKASTEN MIT BEWÄSSERUNGSSYSTEM
SELF-WATERING FLOWER BOX



AQUA FLOR BEWÄSSERUNGSBLUMENKASTEN MIT WASSERSTANDSANZEIGER AQUA FLOR SELF-WATERING FLOWER BOX INCL. WATER LEVEL INDICATOR



SEITE 224
PAGE

● terracotta / terracotta (06)



ART.-NR. MODEL	LxBxH CA. LxWxH APPR.	VE PU	EUROPALETTE* EURO PALLET*
801 060 06	60x22x18,5	5	100
801 080 06	80x22x18,5	5	75
801 100 06	100x22x18,5	5	50

● braun / brown (08)



ART.-NR. MODEL	LxBxH CA. LxWxH APPR.	VE PU	EUROPALETTE* EURO PALLET*
801 060 08	60x22x18,5	5	100
801 080 08	80x22x18,5	5	75
801 100 08	100x22x18,5	5	50

○ weiß / white (10)



ART.-NR. MODEL	LxBxH CA. LxWxH APPR.	VE PU	EUROPALETTE* EURO PALLET*
801 060 10	60x22x18,5	5	100
801 080 10	80x22x18,5	5	75
801 100 10	100x22x18,5	5	50

● anthrazit / anthracite (38)



ART.-NR. MODEL	LxBxH CA. LxWxH APPR.	VE PU	EUROPALETTE* EURO PALLET*
801 060 38	60x22x18,5	5	100
801 080 38	80x22x18,5	5	75
801 100 38	100x22x18,5	5	50

i LIEFERUMFANG:
BEWÄSSERUNGSEINSATZ, WASSERSTANDSANZEIGER,
VERSTÄRKUNGSTREBE
INCLUDED IN DELIVERY: WATERING SYSTEM, WATER LEVEL INDICATOR,
REINFORCEMENT STRUT

i EINFACHE
HANDHABUNG
EASY TO USE



ZUBEHÖR
ACCESSORIES

PRODUKT PRODUCT	TYP TYPE	ART.-NR. MODEL	SEITE PAGE
Blumenkasten-Halter Flower box brackets	UNIVERSAL	39 816 000 ..	197
Blumenkasten-Halter Flower box brackets	A	39 818 000 ..	198
Blumenkasten-Halter Flower box brackets	E	39 814 000 ..	199
Blumenkasten-Untersetzer Flower box saucers		844 ...	195

ERSATZTEIL
SPARE PART

PRODUKT PRODUCT	ART.-NR. MODEL	SEITE PAGE
Wasserstandsanzeiger Water level indicator	900 802 08	213
Verstärkungstrebe Reinforcement strut	900 801 99	213
Bewässerungseinsatz Watering system	900 801 ..	213

WEITERE INFORMATIONEN
FURTHER DETAILS

ERDVOLUMEN CA.
SOIL VOLUME APPR.
WASSERINHALT CA.
WATER-VOLUME APPR.
LÄNGE / LENGTH

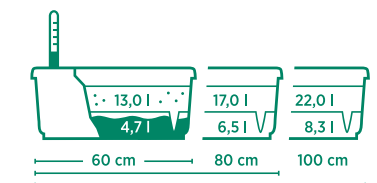

MAYA

BLUMENKASTEN MIT WASSERSPEICHER
FLOWER BOX WITH WATER TANK



Maya - das Komplettpaket: Blumenkasten mit Wasserspeicher und inklusive Halterung!

Maya - the full package:
Flower box with water tank
and bracket

Die clevere Lösung:

- Komplettsset mit Halterung
- Integrierter Abstandshalter
- Wasservorrat ca. 1,5l
- Wasserversorgung über erdgefüllte Kegel
- Überlauföffnungen im Wasserspeicher (überschüssiges Wasser - durch zu starkes Gießen oder Regen verursacht - kann ablaufen, dadurch kein Übernässen der Erde)
- Verbindung aller Teile durch Klick-System
- Gute Stapelfähigkeit, durch innenliegende Halter - platzsparende Lagerung

SMART SOLUTION

- Complete set with mounting bracket
- Integrated spacer
- Water storage appr. 1.5 l
- Water supply via earth-filled cones
- Overflow openings in the water reservoir (excess water - caused by rain or watering too much - can drain, preventing the soil from becoming too wet)
- All parts are connected with a click system
- Good stacking capability, because of inside brackets - space-saving storage



MAYA BLUMENKASTEN MIT WASSERSPEICHER UND HALTERUNG

MAYA FLOWER BOX
WITH WATER TANK AND BRACKET



ART.-NR. MODEL	LxBxH CA. LxWxH APPR.	VE PU
800 050 06	50 x 19 x 18,5	5



ART.-NR. MODEL	LxBxH CA. LxWxH APPR.	VE PU
800 050 31	50 x 19 x 18,5	5



ART.-NR. MODEL	LxBxH CA. LxWxH APPR.	VE PU
800 050 38	50 x 19 x 18,5	5

WEITERE INFORMATIONEN FURTHER DETAILS

ERDVOLUMEN CA.
SOIL VOLUME APPR.
WASSERINHALT CA.
WATER-VOLUME APPR.
LÄNGE / LENGTH

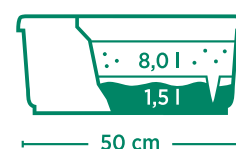

An die Halter, fertig, losgepflanzt!

On your bracket,
ready, plant!

IM LIEFERUMFANG ENTHALTEN IN DELIVERY INCLUDED:

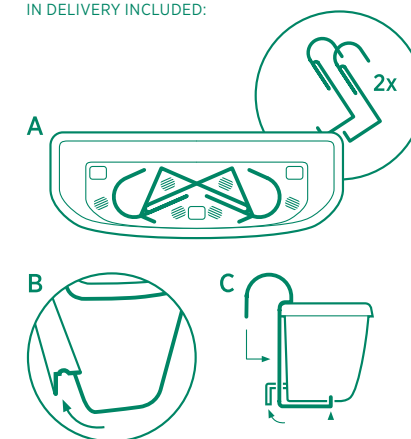

**EINFACHE UND SCHNELLE MONTAGE
MIT DEN BEIDEN ENTHALTENEN
BLUMENKASTENHALTERUNGEN.**
THE TWO BRACKETS INCLUDED MAKE IT QUICK
AND EASY TO PUT THE FLOWER BOX IN PLACE.





Urban Gardening

Urban Gardening

UNSERE URBAN GARDENING-PRODUKTE /
OUR URBAN GARDENING PRODUCTS:

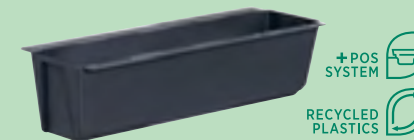

+POS SYSTEM
RECYCLED PLASTICS

EASY PFLANZGEFÄSS
EASY PLANTER



Seite / Page 86

+POS SYSTEM
RECYCLED PLASTICS



CONNYS WAND-/GELÄNDERTOPF
CONNYS WALL AND RAILING PLANTER



Seite / Page 88



+POS SYSTEM

OLIVERA JARDINIÈRE
OLIVERA PLANTER



Seite / Page 90



E&K HOCHBEET
E&K RAISED BED



Seite / Page 92

PRODUKTE AUF DIESER SEITE / PRODUCTS ON THIS PAGE:
CONNYS Wand- und Geländertopf in betonfarbe und anthrazit /
CONNYS wall and railing planter in concrete colour and anthracite

EASY

PFLANZGEFÄSS FÜR EUROPALETTEN PLANTER FOR EURO PALLETS



EASY PFLANZGEFÄSS FÜR EUROPALETTEN EASY PLANTER FOR EURO PALLETS



SEITE 226
PAGE



anthrazit / anthracite (38)



betonfarbe / concrete colour (59)

ART.-NR. MODEL	LxBxH CA. LxWxH APPR.	INHALT CA. VOLUME APPR.	VE PU
802 010 38	10x10x10	0,5	10
802 018 38	18x10x10	1,0	10
802 037 38	37x10x10	2,5	10

ART.-NR. MODEL	LxBxH CA. LxWxH APPR.	INHALT CA. VOLUME APPR.	VE PU
802 010 59	10x10x10	0,5	10
802 018 59	18x10x10	1,0	10
802 037 59	37x10x10	2,5	10



zartrosa / soft pink (86)



zartblau / soft blue (87)

ART.-NR. MODEL	LxBxH CA. LxWxH APPR.	INHALT CA. VOLUME APPR.	VE PU
802 010 86	10x10x10	0,5	10
802 018 86	18x10x10	1,0	10
802 037 86	37x10x10	2,5	10

ART.-NR. MODEL	LxBxH CA. LxWxH APPR.	INHALT CA. VOLUME APPR.	VE PU
802 010 87	10x10x10	0,5	10
802 018 87	18x10x10	1,0	10
802 037 87	37x10x10	2,5	10

PFLANZGEFÄSS FÜR EUROPALETTEN

- Ideal für Europaletten: Der Pflanzkasten passt genau in die Zwischenräume von Europaletten. Er verfügt über extra Schlitzte, in die sich ein zweiter Easy einhängen lässt.
- Universell einsetzbar: Der Easy passt sich mit seinem Hängesystem individuell an die örtlichen Gegebenheiten an und macht auch an Zäunen, Brettern oder Geländern eine gute Figur.

PLANTER FOR EURO PALLETS

- Ideal for Euro pallets: the planter box fits exactly into the spaces between Euro pallets. It has extra slots in which a second Easy can be hooked in.
- Universally applicable: With its hanging system, the Easy adapts individually to the local conditions and also makes a good figure on fences, boards or railings.

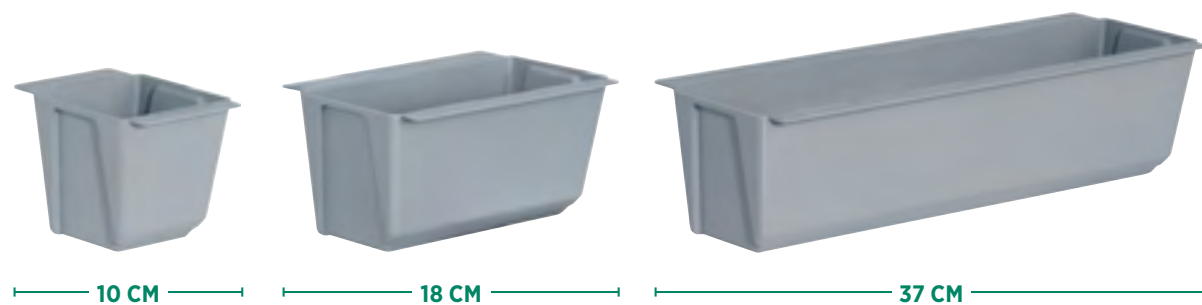

Vielfältige Möglichkeiten

Die Easy-Modelle passen genau zusammen und lassen sich immer wieder neu kombinieren.

MANY POSSIBILITIES
The Easy models fit together perfectly and can be combined over and over again.

i MEHR PFLANZEN AUF WENIGER RAUM: DIE KÄSTEN LASSEN SICH AUCH VOREINANDER PLATZIEREN. MORE PLANTS IN LESS SPACE: THE BOXES CAN ALSO BE PLACED IN FRONT OF EACH OTHER.



CONNYY

WAND- UND GELÄNDERTOPF
WALL AND RAILING PLANTER



Wandmontage /
Wall mounting

CONNYY WAND- UND GELÄNDERTOPF
WALL AND RAILING PLANTER



SEITE 228
PAGE

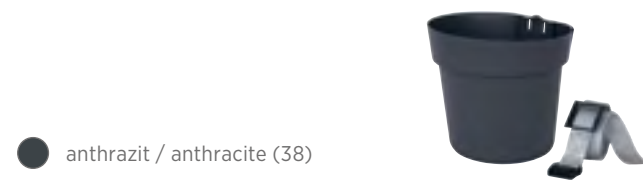

anthrazit / anthracite (38)

ART.-NR. MODEL	GRÖSSE CA. Ø SIZE APPR.	HÖHE CA. HEIGHT APPR.	INHALT CA. VOLUME APPR.	VE PU
320 016 38	16	16	1,6	5

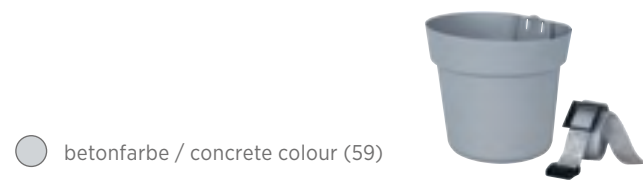

betonfarbe / concrete colour (59)

ART.-NR. MODEL	GRÖSSE CA. Ø SIZE APPR.	HÖHE CA. HEIGHT APPR.	INHALT CA. VOLUME APPR.	VE PU
320 016 59	16	16	1,6	5

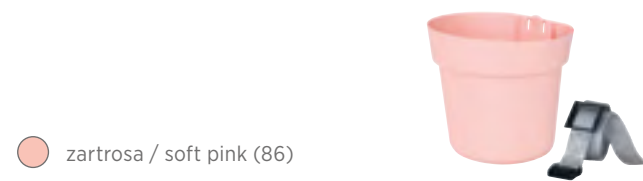

zartrosa / soft pink (86)

ART.-NR. MODEL	GRÖSSE CA. Ø SIZE APPR.	HÖHE CA. HEIGHT APPR.	INHALT CA. VOLUME APPR.	VE PU
320 016 86	16	16	1,6	5

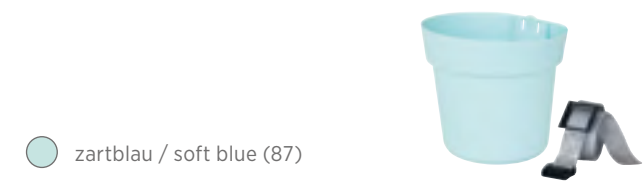

zartblau / soft blue (87)

ART.-NR. MODEL	GRÖSSE CA. Ø SIZE APPR.	HÖHE CA. HEIGHT APPR.	INHALT CA. VOLUME APPR.	VE PU
320 016 87	16	16	1,6	5

Alle Maße in cm, Volumen in Liter / all sizes in cm, volume in litres

Ein Pflanzgefäß, drei Möglichkeiten! One Planter, three options!

**WANDMONTAGE* /
WALL MOUNTING*:**

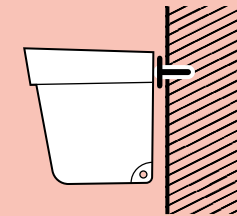

*SCHRAUBE (MAX. M5) UND DÜBEL
NICHT IM LIEFERUMFANG ENTHALTEN
*SCREW (MAX. M5) AND ANCHOR NOT
INCLUDED IN DELIVERY

**HORIZONTALE BEFESTIGUNG MIT GURT /
HORIZONTAL MOUNTING WITH STRAP:**

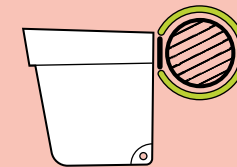

**VERTIKALE BEFESTIGUNG MIT GURT /
VERTICAL MOUNTING WITH STRAP:**

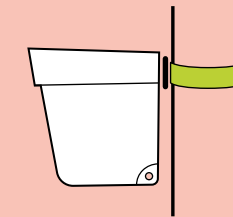

Vertikale Befestigung /
Vertical mounting



10 CM

Für Geländer und
Rohre bis 10cm
Breite geeignet.
Suitable for railings
and pipes up to
10cm wide.



Horizontale Befestigung /
Horizontal mounting

**Flexible
Befestigung:**



Durch das Klick-
system kann der
Gurthalter an der
Rückseite in zwei
Richtungen ein-
gehängt werden.
Dadurch ist der
Wand- und
Geländertopf
flexibel einsetzbar.

FLEXIBLE ATTACHMENT:
Thanks to the click
system, the band
clip at the back
accommodates attachment
in two directions, making this
wall and railing pot highly
flexible.



**LIEFERUMFANG:
TOPF, HALTERUNG, GURT (GRAU)**
INCLUDED IN DELIVERY:
PLANTER, MOUNT BRACKET, STRAP (GREY)



**Conny - Clever
Verpackt:**

Die Verpackung ist so
konzipiert, dass der
Conny optimal und
überall platzsparend
gestapelt werden
kann.

**CONNYY - CLEVER
PACKAGING:**
The packaging is designed
to be stacked space-
savingly everywhere.





OLIVERA

JARDINIÈRE PFLANZGEFÄSS
PLANTER

OLIVERA JARDINIÈRE IM DISPLAY

OLIVERA PLANTER IN DISPLAY



SEITE 229
PAGE



verschiedene Farben /
different colours (99)



ART.-NR. 890 025 96 MODEL	BEZEICHNUNG DESCRIPTION	MENGE/STÜCK QUANTITY/PIECE	FARBCODE COLOUR CODE
	Blumenkasten weiß, 25 cm Flower box white, 25 cm	12	○ 10 – weiß / white
	Blumenkasten anthrazit, 25 cm Flower box anthracite, 25 cm	24	● 38 – anthrazit / anthracite
	Blumenkasten betonfarbe, 25 cm Flower box concrete colour, 25 cm	12	○ 59 – betonfarbe / concrete colour
	Blumenkasten eukalyptus, 25 cm Flower box eucalyptus, 25 cm	12	○ 68 – eukalyptus / eucalyptus
	Blumenkasten zartrosa, 25 cm Flower box soft pink, 25 cm	12	○ 86 – zartrosa / soft pink
gesamt/total		72	



ABNEHMBARER UNTERSETZER
REMOVABLE SAUCER



DISPLAYBOX LxBxH:
62x27x30 CM
DISPLAY BOX LxWxH:
62x27x30 CM



E&K HOCHBEET

E&K RAISED BED



E&K HOCHBEET MIT DECKEL

E&K RAISED BED WITH COVER



● anthrazit / anthracite (38)

ART.-NR. MODEL	LÄNGE CA. LENGTH APPR.	BREITE CA. WIDTH APPR.	HÖHE CA. HEIGHT APPR.	INHALT CA. VOLUME APPR.	VE PU
282 080 38	80	40	88	110	1

ERSATZTEIL
SPARE PART

ERSATZDECKEL FÜR E&K HOCHBEET

ADDITIONAL COVER FOR
E&K RAISED BED

ART.-NR. 283 080 70
MODEL

SEITE 212
PAGE



Pflanzgefäße

Planters



UNSERE PFLANZGEFÄSSE / OUR PLANTERS:

PFLANZTÖPFE / PLANTERS:



STANDARD BLUMENTOPF
STANDARD FLOWER POT



Seite / Page 98



NEVADA BLUMENTOPF
NEVADA FLOWER POT



Seite / Page 100



CYLINDRO BLUMENTOPF
CYLINDRO FLOWER POT



Seite / Page 102



MONTANA BLUMENTOPF
MONTANA FLOWER POT



Seite / Page 104



AZTEKI BLUMENTOPF
AZTEKI FLOWER POT



Seite / Page 106



NORA PFLANZCONTAINER
NORA PLANT CONTAINER



Seite / Page 108

PRODUKTE AUF DIESER SEITE / PRODUCTS ON THIS PAGE:
CYLINDRO in anthrazit und taupe / CYLINDRO in anthracite and taupe

WEITERE PRODUKTE SIEHE NÄCHSTE SEITE /
MORE PRODUCTS ON THE NEXT PAGE

WEITERE PFLANZTÖPFE /
MORE PLANTERS



E&K PFLANZTOPF
E&K PLANTER



Seite / Page 110



E&K PFLANZTOPF 2-FARBIG
E&K PLANTER TWO-COLOURED



Seite / Page 112

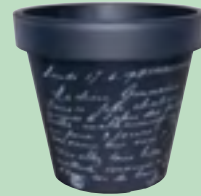

E&K PFLANZTOPF SCHRIFT
E&K PLANTER SCRIPTURED



Seite / Page 113

GELÄNDERTÖPFE /
RAILING PLANTERS:



XXL GELÄNDERBLUMENTOPF
XXL RAILING FLOWER POT



Seite / Page 120



XXL GELÄNDERBLUMENKASTEN
XXL RAILING PLANTER



Seite / Page 120

PFLANZTRÖGE /
PLANT TROUGH



PLATO PFLANZTROG
PLATO TROUGH



Seite / Page 114

BLUMENSPINDELN /
URN PLANTERS:



BLUMENSPINDEL
URN PLANTER



Seite / Page 116

HÄNGEAMPELN /
HANGING BASKETS:



GALICIA HÄNGEAMPEL
GALICIA HANGING BASKET



Seite / Page 124

PFLANZSCHALEN /
BOWL PLANTERS:



JESSICA BLUMENSCHALE
JESSICA FLOWER BOWL



Seite / Page 126



STANDARD PFLANZSCHALE
STANDARD BOWL PLANTER



Seite / Page 127

CONTAINERTÖPFE /
PLANT CONTAINERS:



CONTAINERTOPF
CONTAINER POT



Seite / Page 117



BAUMCONTAINER
TREE CONTAINER



Seite / Page 118



PFLANZCONTAINER MIT GRIFF
PLANT CONTAINER WITH HANDLE



Seite / Page 118

STANDARD

BLUMENTOPF FLOWER POT



STANDARD BLUMENTOPF STANDARD FLOWER POT



SEITE 230 / 242
PAGE

● terracotta / terracotta (06)



ART.-NR. MODEL	GRÖSSE CA. Ø SIZE APPR.	HÖHE CA. HEIGHT APPR.	INHALT CA. VOLUME APPR.	VE PU
806 006 06	6	5,5	0,05	20
806 008 06	8	7,5	0,2	20
806 010 06	10	9,0	0,35	20
806 012 06	12	11,0	0,7	20
806 014 06	14	12,0	1,0	20
806 016 06	16	14,0	1,4	20
806 018 06	18	15,0	2,25	20
806 020 06	20	17,0	3,0	10
806 022 06	22	19,0	4,0	10
806 024 06	24	20,5	5,5	10
806 026 06	26	22,5	6,5	10
806 028 06	28	24,0	8,5	10
806 032 06	32	26,5	13,5	10
806 036 06	36	31,5	19,5	10
806 040 06	40	34,5	26,5	5
806 045 06	45	37,0	34,5	5

● braun / brown (07)



ART.-NR. MODEL	GRÖSSE CA. Ø SIZE APPR.	HÖHE CA. HEIGHT APPR.	INHALT CA. VOLUME APPR.	VE PU
806 006 07	6	5,5	0,05	20
806 008 07	8	7,5	0,2	20
806 010 07	10	9,0	0,35	20
806 012 07	12	11,0	0,7	20
806 014 07	14	12,0	1,0	20
806 016 07	16	14,0	1,4	20
806 018 07	18	15,0	2,25	20
806 020 07	20	17,0	3,0	10
806 022 07	22	19,0	4,0	10
806 024 07	24	20,5	5,5	10
806 026 07	26	22,5	6,5	10
806 028 07	28	24,0	8,5	10
806 032 07	32	26,5	13,5	10
806 036 07	36	31,5	19,5	10
806 040 07	40	34,5	26,5	5
806 045 07	45	37,0	34,5	5

○ weiß / white (10)



ART.-NR. MODEL	GRÖSSE CA. Ø SIZE APPR.	HÖHE CA. HEIGHT APPR.	INHALT CA. VOLUME APPR.	VE PU
806 006 10	6	5,5	0,05	20
806 008 10	8	7,5	0,2	20
806 010 10	10	9,0	0,35	20
806 012 10	12	11,0	0,7	20
806 014 10	14	12,0	1,0	20
806 016 10	16	14,0	1,4	20
806 018 10	18	15,0	2,25	20
806 020 10	20	17,0	3,0	10
806 022 10	22	19,0	4,0	10
806 024 10	24	20,5	5,5	10
806 026 10	26	22,5	6,5	10
806 028 10	28	24,0	8,5	10
806 032 10	32	26,5	13,5	10
806 036 10	36	31,5	19,5	10
806 040 10	40	34,5	26,5	5
806 045 10	45	37,0	34,5	5



AB Ø 14CM AUF EURO-
PALETTE ERHÄLTlich
ON EURO PALLET
AVAILABLE FROM Ø 14 CM

ART.-NR. MODEL	EUROPALETTE** EURO PALLET *
806 006 ..	-
806 008 ..	-
806 010 ..	-
806 012 ..	-
806 014 ..	1800
806 016 ..	1400
806 018 ..	2400
806 020 ..	1920
806 022 ..	1400
806 024 ..	1200
806 026 ..	840
806 028 ..	660
806 032 ..	400
806 036 ..	320
806 040 ..	320
806 045 ..	90



ZUBEHÖR ACCESSORIES

STANDARD BLUMENTOPF UNTERSETZER STANDARD FLOWER POT SAUCER



SEITE 200
PAGE

ART.-NR. BLUMENTOPF MODEL FLOWER POT	ART.-NR. UNTERSETZER MODEL SAUCER
806 006 ..	808 006 ..
806 008 ..	808 008 ..
806 010 ..	808 010 ..
806 012 ..	808 012 ..
806 014 ..	808 012 ..
806 016 ..	808 014 ..
806 018 ..	808 016 ..
806 020 ..	808 018 ..
806 022 ..	808 021 ..
806 024 ..	808 021 ..
806 026 ..	808 024 ..
806 028 ..	808 027 ..
806 032 ..	808 030 ..
806 036 ..	808 034 ..
806 040 ..	808 034 ..
806 045 ..	808 040 ..



NEVADA

BLUMENTOPF
FLOWER POT

NEVADA BLUMENTOPF
NEVADA FLOWER POT

+ POS SYSTEM  SEITE 244
PAGE



 terracotta / terracotta (06)

ART.-NR. MODEL	GRÖSSE CA. Ø SIZE APPR.	HÖHE CA. HEIGHT APPR.	INHALT CA. VOLUME APPR.	VE PU
807 010 06	10,0	8,0	0,4	10
807 012 06	12,0	10,0	0,7	10
807 013 06	13,0	11,0	0,8	10
807 015 06	14,5	12,0	1,2	10
807 017 06	17,0	15,5	2,0	10
807 020 06	20,0	18,0	3,0	10
807 024 06	23,5	20,5	5,0	10
807 027 06	26,5	23,0	7,0	10
807 032 06	31,5	28,5	13,0	5
807 035 06	34,5	30,5	16,0	5



 anthrazit / anthracite (38)

ART.-NR. MODEL	GRÖSSE CA. Ø SIZE APPR.	HÖHE CA. HEIGHT APPR.	INHALT CA. VOLUME APPR.	VE PU
807 010 38	10,0	8,0	0,4	10
807 012 38	12,0	10,0	0,7	10
807 013 38	13,0	11,0	0,8	10
807 015 38	14,5	12,0	1,2	10
807 017 38	17,0	15,5	2,0	10
807 020 38	20,0	18,0	3,0	10
807 024 38	23,5	20,5	5,0	10
807 027 38	26,5	23,0	7,0	10
807 032 38	31,5	28,5	13,0	5
807 035 38	34,5	30,5	16,0	5



Beispielbild / Example image

CYLINDRO UNTERSETZER
CYLINDRO SAUCER

 
SEITE 202
PAGE



ART.-NR. BLUMENTOPF MODEL FLOWER POT	ART.-NR. UNTERSETZER MODEL SAUCER
807 010 ..	642 011 ..
807 012 ..	642 011 ..
807 013 ..	642 013 ..
807 015 ..	642 013 ..
807 017 ..	642 017 ..
807 020 ..	642 021 ..
807 024 ..	642 021 ..
807 027 ..	642 025 ..
807 032 ..	642 029 ..
807 035 ..	642 029 ..

 **ZUBEHÖR**
ACCESSORIES





CYLINDRO

BLUMENTOPF
FLOWER POT

CYLINDRO BLUMENTOPF CYLINDRO FLOWER POT



SEITE 232 / 240
PAGE



● terracotta / terracotta (06)



● olivgrün / olive (12)

ART.-NR. MODEL	GRÖSSE CA. Ø SIZE APPR.	HÖHE CA. HEIGHT APPR.	INHALT CA. VOLUME APPR.	VE PU
641 012 06	12	9,5	0,6	10
641 016 06	16	12,5	1,4	10
641 020 06	20	15,5	3,0	10
641 025 06	25	19,5	5,5	10
641 030 06	30	22,5	9,5	10
641 035 06	35	25,5	14,5	10
641 040 06	40	28,0	21,5	10
641 045 06	45	32,5	30,0	10
641 050 06	50	36,5	42,0	5
641 060 06	60	41,5	72,0	5

ART.-NR. MODEL	GRÖSSE CA. Ø SIZE APPR.	HÖHE CA. HEIGHT APPR.	INHALT CA. VOLUME APPR.	VE PU
-	-	-	-	-
-	-	-	-	-
641 020 12	20	15,5	3,0	10
641 025 12	25	19,5	5,5	10
641 030 12	30	22,5	9,5	10
641 035 12	35	25,5	14,5	10
641 040 12	40	28,0	21,5	10
-	-	-	-	-
641 050 12	50	36,5	42,0	5
641 060 12	60	41,5	72,0	5



● anthrazit / anthracite (38)



● taupe / taupe (40)

ART.-NR. MODEL	GRÖSSE CA. Ø SIZE APPR.	HÖHE CA. HEIGHT APPR.	INHALT CA. VOLUME APPR.	VE PU
641 012 38	12	9,5	0,6	10
641 016 38	16	12,5	1,4	10
641 020 38	20	15,5	3,0	10
641 025 38	25	19,5	5,5	10
641 030 38	30	22,5	9,5	10
641 035 38	35	25,5	14,5	10
641 040 38	40	28,0	21,5	10
641 045 38	45	32,5	30,0	10
641 050 38	50	36,5	42,0	5
641 060 38	60	41,5	72,0	5

ART.-NR. MODEL	GRÖSSE CA. Ø SIZE APPR.	HÖHE CA. HEIGHT APPR.	INHALT CA. VOLUME APPR.	VE PU
641 012 40	12	9,5	0,6	10
641 016 40	16	12,5	1,4	10
641 020 40	20	15,5	3,0	10
641 025 40	25	19,5	5,5	10
641 030 40	30	22,5	9,5	10
641 035 40	35	25,5	14,5	10
641 040 40	40	28,0	21,5	10
641 045 40	45	32,5	30,0	10
641 050 40	50	36,5	42,0	5
641 060 40	60	41,5	72,0	5

CYLINDRO UNTERSETZER CYLINDRO SAUCER



SEITE 202
PAGE



ART.-NR. BLUMENTOPF MODEL FLOWER POT	ART.-NR. UNTERSETZER MODEL SAUCER
641 012 ..	642 013 ..
641 016 ..	642 017 ..
641 020 ..	642 021 ..
641 025 ..	642 025 ..
641 030 ..	642 029 ..
641 035 ..	642 033 ..
641 040 ..	642 037 ..
641 045 ..	642 041 ..
641 050 ..	642 045 ..
641 060 ..	642 053 ..



Beispielbild / Example image



ZUBEHÖR
ACCESSORIES



MONTANA

BLUMENTOPF
FLOWER POT



UNSERE MONTANA-SERIE WEIST IN DER GRÖSSENSTAFFELUNG LEICHTE OPTISCHE UNTERSCHIEDE AUF. OUR MONTANA RANGE HAS SLIGHT OPTICAL DIFFERENCES IN SIZE GRADUATION.



MONTANA BLUMENTOPF MONTANA FLOWER POT



● terracotta / terracotta (06)

ART.-NR. MODEL	GRÖSSE CA. Ø SIZE APPR.	HÖHE CA. HEIGHT APPR.	INHALT CA. VOLUME APPR.	VE PU
640 020 06	20	16,0	2,4	10
640 025 06	25	19,5	5,0	10
640 030 06	30	22,5	9,0	10
640 035 06	35	25,5	14,0	10
640 040 06	40	28,5	21,0	10
640 045 06	45	32,5	32,5	5
640 050 06	50	36,5	44,0	5
640 060 06	60	41,5	75,0	5
640 070 06	70	49,0	98,0	1
640 080 06	80	56,0	158,0	1

● anthrazit / anthracite (38)



ART.-NR. MODEL	GRÖSSE CA. Ø SIZE APPR.	HÖHE CA. HEIGHT APPR.	INHALT CA. VOLUME APPR.	VE PU
640 020 38	20	16,0	2,4	10
640 025 38	25	19,5	5,0	10
640 030 38	30	22,5	9,0	10
640 035 38	35	25,5	14,0	10
640 040 38	40	28,5	21,0	10
640 045 38	45	32,5	32,5	5
640 050 38	50	36,5	44,0	5
640 060 38	60	41,5	75,0	5
640 070 38	70	49,0	98,0	1
640 080 38	80	56,0	158,0	1



MONTANA UNTERSETZER MONTANA SAUCER



SEITE 204
PAGE



ART.-NR. BLUMENTOPF MODEL FLOWER POT	ART.-NR. UNTERSETZER MODEL SAUCER
640 020 ..	655 020 ..
640 025 ..	655 022 ..
640 030 ..	655 026 ..
640 035 ..	655 032 ..
640 040 ..	655 038 ..
640 045 ..	655 042 ..
640 050 ..	655 050 ..
640 060 ..	655 058 ..
640 070 ..	655 064 ..
640 080 ..	655 078 ..



Beispielbild / Example image

ZUBEHÖR
ACCESSORIES





AZTEKI

BLUMENTOPF
FLOWER POT

AZTEKI BLUMENTOPF AZTEKI FLOWER POT

RECYCLED
PLASTICS 



 terracotta / terracotta (06)

ART.-NR. MODEL	GRÖSSE CA. Ø SIZE APPR.	HÖHE CA. HEIGHT APPR.	INHALT CA. VOLUME APPR.	VE PU
695 020 06	20	16,5	2,5	10
695 025 06	25	20,5	5,0	10
695 030 06	30	24,5	8,5	10
695 040 06	40	32,5	19,5	5
695 050 06	50	40,5	40,0	5

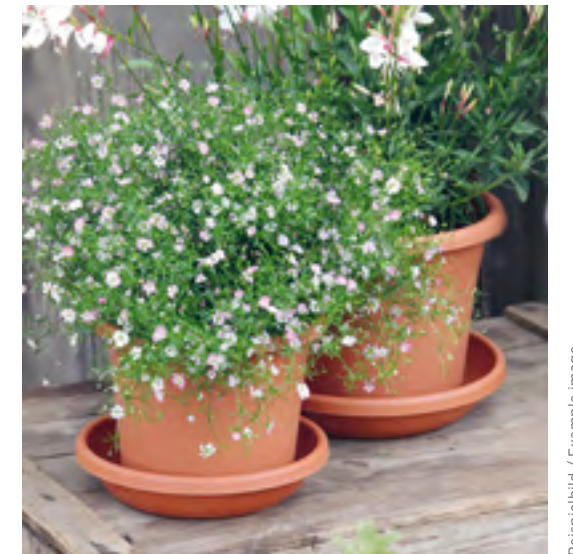

Beispielbild / Example image

 **ZUBEHÖR**
ACCESSORIES

CYLINDRO UNTERSETZER CYLINDRO SAUCER

 **SEITE 202**
PAGE



ART.-NR. BLUMENTOPF MODEL FLOWER POT	ART.-NR. UNTERSETZER MODEL SAUCER
695 020 ..	642 017 ..
695 025 ..	642 021 ..
695 030 ..	642 025 ..
695 040 ..	642 033 ..
695 050 ..	642 037 ..



 **VERSTÄRKUNGSRIPPEN
STABILISIEREN DEN RAND**
REINFORCEMENT RIBS STABILISE
THE EDGE

 **ENTWÄSSERUNGSÖFFNUNG AM
BODEN VERMINDERT STAUNÄSSE**
DRAINAGE OPENING AT THE BOTTOM
REDUCES WATERLOGGING



 anthrazit / anthracite (38)

ART.-NR. MODEL	GRÖSSE CA. Ø SIZE APPR.	HÖHE CA. HEIGHT APPR.	INHALT CA. VOLUME APPR.	VE PU
695 020 38	20	16,5	2,5	10
695 025 38	25	20,5	5,0	10
695 030 38	30	24,5	8,5	10
695 040 38	40	32,5	19,5	5
695 050 38	50	40,5	40,0	5



NORA

PFLANZCONTAINER
PLANT CONTAINER

NORA PFLANZCONTAINER NORA PLANT CONTAINER



SEITE 233
PAGE



● terracotta / terracotta (06)

ART.-NR. MODEL	GRÖSSE CA. SIZE APPR.	HÖHE CA. HEIGHT APPR.	BODENMASS CA. GROUND DIMENSION APPR.	INHALT CA. VOLUME APPR.	VE PU
687 023 06	23,0	18,5	14,5	4,5	10
687 028 06	27,5	22,0	17,8	8,0	10
687 033 06	32,5	26,0	21,0	13,0	10
687 040 06	39,0	31,5	25,0	22,5	10
687 048 06	48,0	38,0	30,5	43,0	10
687 058 06	57,0	45,0	36,5	70,0	10



● anthrazit / anthracite (38)

ART.-NR. MODEL	GRÖSSE CA. SIZE APPR.	HÖHE CA. HEIGHT APPR.	BODENMASS CA. GROUND DIMENSION APPR.	INHALT CA. VOLUME APPR.	VE PU
687 023 38	23,0	18,5	14,5	4,5	10
687 028 38	27,5	22,0	17,8	8,0	10
687 033 38	32,5	26,0	21,0	13,0	10
687 040 38	39,0	31,5	25,0	22,5	10
687 048 38	48,0	38,0	30,5	43,0	10
687 058 38	57,0	45,0	36,5	70,0	10



NORA UNTERSETZER NORA SAUCER



SEITE 205
PAGE



ART.-NR. PFLANZCONTAINER MODEL PLANT CONTAINER	ART.-NR. UNTERSETZER MODEL SAUCER
687 023 ..	688 020 ..
687 028 ..	688 025 ..
687 033 ..	688 029 ..
687 040 ..	688 035 ..
687 048 ..	688 040 ..
687 058 ..	688 050 ..



ZUBEHÖR
ACCESSORIES



E & K PFLANZTOPF

E & K PLANTER



E & K PFLANZTOPF E & K PLANTER



● anthrazit / anthracite (38)

ART.-NR. MODEL	GRÖSSE CA. Ø SIZE APPR.	HÖHE CA. HEIGHT APPR.	INHALT CA. VOLUME APPR.	VE PU
310 025 38	25	22,0	5,9	1
310 030 38	29	26,0	10,0	1
310 035 38	34	30,5	16,0	1
310 040 38	39	35,0	24,0	1
310 050 38	48	43,0	46,0	1
310 060 38	58	52,0	82,0	1
310 080 38	80	68,0	200,0	1



● cremeweiß / cream white (56)

ART.-NR. MODEL	GRÖSSE CA. Ø SIZE APPR.	HÖHE CA. HEIGHT APPR.	INHALT CA. VOLUME APPR.	VE PU
-	-	-	-	-
310 030 56	29	26,0	10,0	1
310 035 56	34	30,5	16,0	1
310 040 56	39	35,0	24,0	1
310 050 56	48	43,0	46,0	1
310 060 56	58	52,0	82,0	1
-	-	-	-	-



E & K PFLANZTOPF 2-FARBIG

E & K PLANTER TWO-COLOURED



E & K PFLANZTOPF 2-FARBIG

E & K PLANTER TWO-COLOURED

+ POS SYSTEM SEITE 233 PAGE

eukalyptus & weiß / eucalyptus & white (88)



blaugrau & weiß / blue-gray & white (89)



ART.-NR. MODEL	GRÖSSE CA. Ø SIZE APPR.	HÖHE CA. HEIGHT APPR.	INHALT CA. VOLUME APPR.	VE PU
310 025 88	24,5	22	5,9	1
310 030 88	29,0	26	10,0	1
310 040 88	39,0	35	24,0	1

ART.-NR. MODEL	GRÖSSE CA. Ø SIZE APPR.	HÖHE CA. HEIGHT APPR.	INHALT CA. VOLUME APPR.	VE PU
310 025 89	24,5	22	5,9	1
310 030 89	29,0	26	10,0	1
310 040 89	39,0	35	24,0	1

E & K PFLANZTOPF MIT SCHRIFT

E & K PLANTER WITH SCRIPTURE



old letter dunkel / old letter dark (53)

ART.-NR. MODEL	GRÖSSE CA. Ø SIZE APPR.	HÖHE CA. HEIGHT APPR.	INHALT CA. VOLUME APPR.	VE PU
311 040 53	39	45	29	1

E & K PFLANZTOPF MIT SCHRIFT

E & K PLANTER WITH SCRIPTURE



PLATO

PFLANZTROG
PLANT TROUGH



PLATO UNTERSETZER PLATO SAUCER



SEITE 209
PAGE



ART.-NR. PFLANZTROG MODEL PLANT TROUGH	ART.-NR. UNTERSETZER MODEL SAUCER
836 060 ..	846 060 ..
836 080 ..	846 080 ..
836 100 ..	846 100 ..



ZUBEHÖR
ACCESSORIES

PLATO PFLANZTROG PLATO PLANT TROUGH



● terracotta / terracotta (06)

ART.-NR. MODEL	LÄNGE CA. LENGTH APPR.	BREITE CA. WIDTH APPR.	HÖHE CA. HEIGHT APPR.	INHALT CA. VOLUME APPR.	VE PU
836 060 06	60	30	27	30	5
836 080 06	80	37	32	60	5
836 100 06	100	44	39	110	5



● anthrazit / anthracite (38)

ART.-NR. MODEL	LÄNGE CA. LENGTH APPR.	BREITE CA. WIDTH APPR.	HÖHE CA. HEIGHT APPR.	INHALT CA. VOLUME APPR.	VE PU
836 060 38	60	30	27	30	5
836 080 38	80	37	32	60	5
836 100 38	100	44	39	110	5



BLUMENSPINDEL

URN PLANTER



BLUMENSPINDEL
URN PLANTER

● anthrazit / anthracite (38)



ART.-NR. MODEL	GRÖSSE CA. Ø SIZE APPR.	HÖHE CA. HEIGHT APPR.	INHALT CA. VOLUME APPR.	VE PU
661 040 38	40	36	10	10

CONTAINERTOPF CONTAINER POT

● terracotta / terracotta (06)



ART.-NR. MODEL	GRÖSSE CA. Ø SIZE APPR.	HÖHE CA. HEIGHT APPR.	INHALT CA. VOLUME APPR.	VE PU
342 011 06	11	10,0	0,6	20
342 012 06	12	11,0	0,7	20
342 013 06	13	11,5	1,0	20
342 014 06	14	13,0	1,4	20
342 015 06	15	14,0	1,7	20
342 017 06	17	16,0	2,4	10

ART.-NR. MODEL	GRÖSSE CA. Ø SIZE APPR.	HÖHE CA. HEIGHT APPR.	INHALT CA. VOLUME APPR.	VE PU
342 019 06	19	17,0	3,5	10
342 021 06	21	19,0	5,0	10
342 024 06	24	22,0	7,0	10
342 027 06	27	25,0	10,0	10
342 030 06	30	27,5	14,0	10
342 033 06	33	29,5	18,0	5

CONTAINER- TOPF

CONTAINER POT





PFLANZ-CONTAINER

MIT GRIF
PLANT CONTAINER WITH HANDLE

BAUM-CONTAINER

TREE CONTAINER

BAUMCONTAINER TREE CONTAINER



● schwarz / black (14)

ART.-NR. MODEL	GRÖSSE CA. Ø SIZE APPR.	HÖHE CA. HEIGHT APPR.	INHALT CA. VOLUME APPR.	VE PU
343 022 14	22	17	5,5	10
343 024 14	24	20	7,5	10
343 026 14	26	22	10,0	10
343 028 14	28	24	12,0	10
343 030 14	30	26	15,0	10
343 035 14	35	28	25,0	10

PFLANZCONTAINER MIT GRIF PLANT CONTAINER WITH HANDLE



● schwarz / black (14)

ART.-NR. MODEL	GRÖSSE CA. Ø SIZE APPR.	HÖHE CA. HEIGHT APPR.	INHALT CA. VOLUME APPR.	VE PU
344 040 14	40	33	30	5
344 045 14	45	37	35	5
344 050 14	50	40	50	5
344 055 14	55	44	70	5
344 060 14	60	46	85	5
344 065 14	65	49	110	5



XXL GELÄNDER- BLUMENTOPF

MIT WASSERSPEICHER
RAILING FLOWER POT
WITH WATER TANK



4,5 CM

Für Geländer
bis 4,5 cm Breite
geeignet.
For handrails
up to 4.5 cm wide.

XXL GELÄNDERBLUMENTOPF MIT WASSERSPEICHER XXL RAILING FLOWER POT WITH WATER TANK



○ weiß / white (10)

ART.-NR. MODEL	LÄNGE CA. LENGTH APPR.	BREITE CA. WIDTH APPR.	HÖHE CA. HEIGHT APPR.	VE PU
316 030 10	30	27	24,5	1



● anthrazit / anthracite (38)

ART.-NR. MODEL	LÄNGE CA. LENGTH APPR.	BREITE CA. WIDTH APPR.	HÖHE CA. HEIGHT APPR.	VE PU
316 030 38	30	27	24,5	1

Einfache Montage

Die im System enthaltenen, einfach zu montierenden Clips ermöglichen eine sichere Befestigung am Geländer. Für Verkauf und Transport sind die Clips auf der Innenseite des Geländertopfs angebracht.

EASY MOUNTING

The easy-to-install clips included in the system allow a secure attachment to the railing. The clips are stored inside the railing flower pot when it is on sale and in transit.



LIEFERUMFANG:
TOPF, BEFESTIGUNGSCLIPS
INCLUDED IN DELIVERY:
FLOWER POT, MOUNTING CLIPS



**ANSICHT INNEN
MIT AUFBEWAHRUNG DER CLIPS**
INSIDE VIEW
CLIPS NOT IN USE



**ANSICHT UNTERSEITE
MIT MONTIERTEN CLIPS**
BOTTOM VIEW
CLIPS IN USE

WEITERE INFORMATIONEN FURTHER DETAILS

ERDVOLUMEN CA.
SOIL VOLUME APPR.

WASSERINHALT CA.
WATER-VOLUME APPR.

LÄNGE / LENGTH

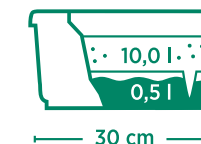

XXL GELÄNDER- BLUMENKASTEN

MIT WASSERSPEICHER
RAILING PLANTER
WITH WATER TANK



4,5 CM

Für Geländer
bjs 4,5cm Breite
geeignet.
For handrails
up to 4,5 cm wide.

XXL GELÄNDERBLUMENKASTEN MIT WASSERSPEICHER XXL RAILING PLANTER WITH WATER TANK



○ weiß / white (10)

ART.-NR. MODEL	LÄNGE CA. LENGTH APPR.	BREITE CA. WIDTH APPR.	HÖHE CA. HEIGHT APPR.	VE PU
319 060 10	58	27	24,5	1



● anthrazit / anthracite (38)

ART.-NR. MODEL	LÄNGE CA. LENGTH APPR.	BREITE CA. WIDTH APPR.	HÖHE CA. HEIGHT APPR.	VE PU
319 060 38	58	27	24,5	1



LIEFERUMFANG:
KASTEN, BEFESTIGUNGSCLIPS
INCLUDED IN DELIVERY:
PLANTER, MOUNTING CLIPS

Einfache Montage

Die im System enthaltenen, einfach zu montierenden Clips ermöglichen eine sichere Befestigung am Geländer. Für Verkauf und Transport sind die Clips auf der Innenseite des Geländerkastens angebracht.

EASY MOUNTING

The easy-to-install clips included in the system allow a secure attachment to the railing. The clips are stored inside the railing planter when it is on sale and in transit.



**ANSICHT INNEN
MIT AUFBEWAHRUNG DER CLIPS**
INSIDE VIEW
CLIPS NOT IN USE



**ANSICHT UNTERSEITE
MIT MONTIERTEN CLIPS**
BOTTOM VIEW
CLIPS IN USE

WEITERE INFORMATIONEN FURTHER DETAILS

ERDVOLUMEN CA.
SOIL VOLUME APPR.
WASSERINHALT CA.
WATER-VOLUME APPR.



LÄNGE / LENGTH

58 cm





GALICIA

HÄNGEAMPEL INKL. UNTERSETZER UND AUFHÄNGER
HANGING BASKET INCL. SAUCER AND HANGER

**GALICIA HÄNGEAMPEL
MIT UNTERSETZER UND AUFHÄNGER**
GALICIA HANGING BASKET
INCL. SAUCER AND HANGER

+ POS SYSTEM  SEITE 231
PAGE



● terracotta / terracotta (06)

ART.-NR. MODEL	GRÖSSE CA. Ø SIZE APPR.	HÖHE TOPF CA. HEIGHT POT APPR.	INHALT CA. VOLUME APPR.	VE PU
643 025 06	25	16	3,5	10
643 030 06	30	19	6,0	10



● braun / brown (08)

ART.-NR. MODEL	GRÖSSE CA. Ø SIZE APPR.	HÖHE TOPF CA. HEIGHT POT APPR.	INHALT CA. VOLUME APPR.	VE PU
643 025 08	25	16	3,5	10
643 030 08	30	19	6,0	10



○ weiß / white (10)

ART.-NR. MODEL	GRÖSSE CA. Ø SIZE APPR.	HÖHE TOPF CA. HEIGHT POT APPR.	INHALT CA. VOLUME APPR.	VE PU
643 025 10	25	16	3,5	10
643 030 10	30	19	6,0	10



● anthrazit / anthracite (38)

ART.-NR. MODEL	GRÖSSE CA. Ø SIZE APPR.	HÖHE TOPF CA. HEIGHT POT APPR.	INHALT CA. VOLUME APPR.	VE PU
643 025 38	25	16	3,5	10
643 030 38	30	19	6,0	10

ERSATZTEIL
SPARE PART

AUFHÄNGER FÜR GALICIA
HANGER FOR GALICIA



SEITE 212
PAGE



ART.-NR. HÄNGEAMPEL MODEL HANGING BASKET	ART.-NR. AUFHÄNGER MODEL HANGER
643 025 ..	900 644 ..
643 030 ..	900 645 ..

JESSICA

BLUMENSCHALE
FLOWER BOWL



STANDARD PFLANZSCHALE STANDARD BOWL PLANTER



● terracotta / terracotta (06)



● anthrazit / anthracite (38)

ART.-NR. MODEL	GRÖSSE CA. Ø SIZE APPR.	HÖHE CA. HEIGHT APPR.	INHALT CA. VOLUME APPR.	VE PU
850 023 06	23	10	2,0	10
850 027 06	27	12	3,5	10
850 034 06	34	14	6,5	10
850 038 06	38	15	9,0	10
850 044 06	44	17	13,5	10
850 052 06	52	19	22,0	5

ART.-NR. MODEL	GRÖSSE CA. Ø SIZE APPR.	HÖHE CA. HEIGHT APPR.	INHALT CA. VOLUME APPR.	VE PU
850 023 38	23	10	2,0	10
850 027 38	27	12	3,5	10
850 034 38	34	14	6,5	10
850 038 38	38	15	9,0	10
850 044 38	44	17	13,5	10
850 052 38	52	19	22,0	5

JESSICA BLUMENSCHALE JESSICA FLOWER BOWL



● terracotta / terracotta (06)



● anthrazit / anthracite (38)

ART.-NR. MODEL	GRÖSSE CA. Ø SIZE APPR.	HÖHE CA. HEIGHT APPR.	INHALT CA. VOLUME APPR.	VE PU
651 020 06	20	7,0	1,0	10
651 025 06	25	9,0	2,0	10
651 030 06	30	11,0	4,9	10
651 035 06	35	12,7	5,0	10
651 040 06	40	14,5	8,0	10
651 045 06	45	16,5	12,5	10
651 050 06	50	18,0	15,5	10
651 060 06	60	21,5	29,0	10

ART.-NR. MODEL	GRÖSSE CA. Ø SIZE APPR.	HÖHE CA. HEIGHT APPR.	INHALT CA. VOLUME APPR.	VE PU
651 020 38	20	7,0	1,0	10
651 025 38	25	9,0	2,0	10
651 030 38	30	11,0	4,9	10
651 035 38	35	12,7	5,0	10
651 040 38	40	14,5	8,0	10
651 045 38	45	16,5	12,5	10
651 050 38	50	18,0	15,5	10
651 060 38	60	21,5	29,0	10

STANDARD

PFLANZSCHALE
BOWL PLANTER



Serie Kubus

Kubus range

UNSERE PFLANZGEFÄSSE DER SERIE KUBUS /
OUR PLANTERS IN THE KUBUS RANGE:



KUBUS PFLANZGEFÄSS QUADRATISCH
KUBUS PLANTER SQUARE



Seite / Page 130



KUBUS PFLANZGEFÄSS RECHTECKIG
KUBUS PLANTER RECTANGULAR



Seite / Page 131



KUBUS PFLANZGEFÄSS SÄULE
KUBUS PLANTER COLUMN



Seite / Page 132

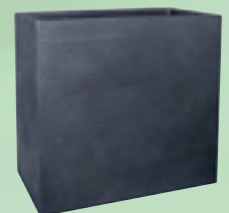

KUBUS RAUMTEILER
KUBUS PARTITION



Seite / Page 134

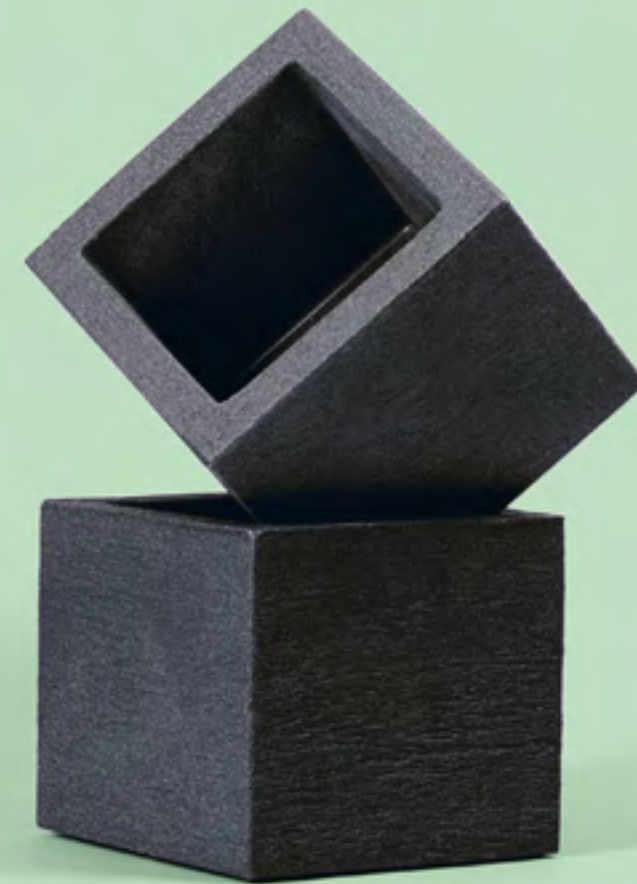

BREITENANGABEN
WIDTH INFORMATION

Außenmaß Outside dimension
Innenmaß Inside dimension



Bodenmaß Ground dimension

PRODUKTE AUF DIESER SEITE / PRODUCTS ON THIS PAGE:
KUBUS Pflanzgefäß quadratisch in anthrazit /
KUBUS Planter square in anthracite



KUBUS

PFLANZGEFÄSS QUADRATISCH
PLANTER SQUARE

KUBUS PFLANZGEFÄSS QUADRATISCH KUBUS PLANTER SQUARE

+ POS SYSTEM  SEITE 235
PAGE



● anthrazit / anthracite (38)

ART.-NR. MODEL	AUSSENMASS CA. OUTSIDE DIMENSION APPR.	HÖHE CA. HEIGHT APPR.	INNENMASS CA. INSIDE DIMENSION APPR.	BODENMASS CA. GROUND DIMENSION APPR.	INHALT CA. VOLUME APPR.	VE PU
133 020 38	20x20	18	17x17	20x20	6	1
133 030 38	30x30	26	21x21	30x30	9	1
133 040 38	40x40	34	31x31	40x40	26	1
133 050 38	50x50	42	41x41	50x50	55	1

KUBUS PFLANZGEFÄSS RECHTECKIG KUBUS PLANTER RECTANGULAR



● anthrazit / anthracite (38)

ART.-NR. MODEL	AUSSENMASS CA. OUTSIDE DIMENSION APPR.	HÖHE CA. HEIGHT APPR.	INNENMASS CA. INSIDE DIMENSION APPR.	BODENMASS CA. GROUND DIMENSION APPR.	INHALT CA. VOLUME APPR.	VE PU
134 080 38	80x30	27	72x22	80x30	32	1



KUBUS

PFLANZGEFÄSS RECHTECKIG
PLANTER RECTANGULAR



KUBUS

PFLANZGEFÄSS SÄULE
PLANTER COLUMN

STRUKTUR

Unterschiedliche
Oberflächen-
strukturen der
beiden Größen
Different surface
structures of
the two sizes

KUBUS PFLANZGEFÄSS SÄULE KUBUS PLANTER COLUMN



● anthrazit / anthracite (38)

ART.-NR. MODEL	AUSSENMASS CA. OUTSIDE DIMENSION APPR.	HÖHE CA. HEIGHT APPR.	INNENMASS CA. INSIDE DIMENSION APPR.	BODENMASS CA. GROUND DIMENSION APPR.	INHALT CA. VOLUME APPR.	VE PU
157 040 38	30 x 30	40	25 x 25	30 x 30	15	1
157 080 38	30 x 30	80	21 x 21	30 x 30	16	1

WEITERE INFORMATIONEN FURTHER DETAILS

**DAS PFLANZGEFÄSS BEINHÄLTET EINEN EINSATZ,
WODURCH NUR EIN TEIL MIT ERDE BEFÜLLT WERDEN MUSS.
SIEHE LITERANGABE.**

THE PLANTER HAS AN INSERT, SO IT DOESN'T ALL HAVE TO BE FILLED
WITH SOIL. SEE LITRE INDICATOR.





KUBUS

RAUMTEILER
PARTITION

KUBUS RAUMTEILER KUBUS PARTITION



● anthrazit / anthracite (38)

ART.-NR. MODEL	AUSSENMASS CA. OUTSIDE DIMENSION APPR.	HÖHE CA. HEIGHT APPR.	INNENMASS CA. INSIDE DIMENSION APPR.	BODENMASS CA. GROUND DIMENSION APPR.	INHALT CA. VOLUME APPR.	VE PU
163 060 38	60x26	60	55x21	60x26	28	1

WEITERE INFORMATIONEN FURTHER DETAILS

DAS PFLANZGEFÄSS BEINHÄLTET EINEN EINSATZ, WODURCH NUR EIN TEIL MIT ERDE BEFÜLLT WERDEN MUSS. SIEHE LITERANGABE.

THE PLANTER HAS AN INSERT, SO IT DOESN'T ALL HAVE TO BE FILLED WITH SOIL. SEE LITRE INDICATOR.



Serie Rillen

Rillen range



UNSERE PFLANZGEFÄSSE DER SERIE RILLEN / OUR PLANTERS IN THE RILLEN RANGE:

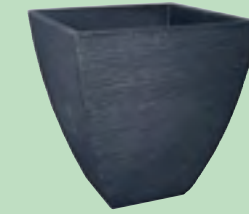

RILLEN PFLANZTOPF QUADRAT
GROOVED PLANTER SQUARE



Seite / Page 138



RILLEN PFLANZTOPF RUND
GROOVED PLANTER ROUND



Seite / Page 140



RILLEN PFLANZTOPF KUBUS QUADRAT
GROOVED PLANTER KUBUS SQUARE



Seite / Page 142



RILLEN TROG
GROOVED TROUGH



Seite / Page 144



RILLEN SCHALE QUADRAT
GROOVED BOWL SQUARE



Seite / Page 146



RILLEN SCHALE RUND
GROOVED BOWL ROUND



Seite / Page 146

i BREITENANGABEN
WIDTH INFORMATION

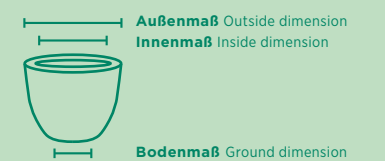

PRODUKTE AUF DIESER SEITE / PRODUCTS ON THIS PAGE:
RILLEN Pflanztopf quadrat, Rillen Pflanztopf rund in betonfarbe /
Grooved planter square, Grooved planter round in concrete colour



RILLEN

PFLANZTOPF QUADRAT
GROOVED PLANTER SQUARE

RILLEN PFLANZTOPF QUADRAT GROOVED PLANTER SQUARE



SEITE 234
PAGE



● anthrazit / anthracite (38)

ART.-NR. MODEL	AUSSENMASS CA. OUTSIDE DIMENSION APPR.	HÖHE CA. HEIGHT APPR.	INNENMASS CA. INSIDE DIMENSION APPR.	BODENMASS CA. GROUND DIMENSION APPR.	INHALT CA. VOLUME APPR.	VE PU
158 040 38	40 x 40	42	35 x 35	18,5 x 18,5	40	1
158 060 38	40 x 40	60	35 x 35	18,5 x 18,5	63	1

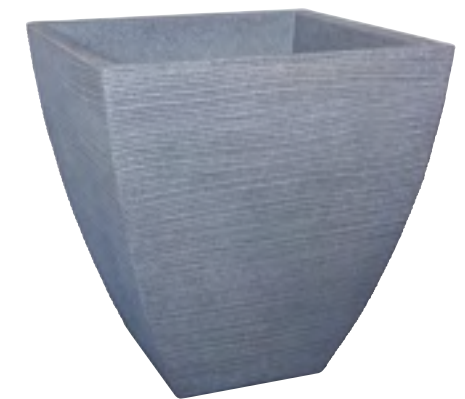

● betonfarbe / concrete colour (58)

ART.-NR. MODEL	AUSSENMASS CA. OUTSIDE DIMENSION APPR.	HÖHE CA. HEIGHT APPR.	INNENMASS CA. INSIDE DIMENSION APPR.	BODENMASS CA. GROUND DIMENSION APPR.	INHALT CA. VOLUME APPR.	VE PU
158 040 58	40 x 40	42	35 x 35	18,5 x 18,5	40	1
158 060 58	40 x 40	60	35 x 35	18,5 x 18,5	63	1





RILLEN

PFLANZTOPF RUND
GROOVED PLANTER ROUND

RILLEN PFLANZTOPF RUND
GROOVED PLANTER ROUND



SEITE 235
PAGE



● anthrazit / anthracite (38)

ART.-NR. MODEL	AUSSENMASS CA. Ø OUTSIDE DIMENSION APPR.	HÖHE CA. HEIGHT APPR.	INNENMASS CA. Ø INSIDE DIMENSION APPR.	BODENMASS CA. Ø GROUND DIMENSION APPR.	INHALT CA. VOLUME APPR.	VE PU
153 031 38	40	31	35,0	17,5	25,5	1
153 042 38	40	42	34,5	18,5	32,0	1
153 060 38	40	60	35,0	19,5	47,0	1



● betonfarbe / concrete colour (58)

ART.-NR. MODEL	AUSSENMASS CA. Ø OUTSIDE DIMENSION APPR.	HÖHE CA. HEIGHT APPR.	INNENMASS CA. Ø INSIDE DIMENSION APPR.	BODENMASS CA. Ø GROUND DIMENSION APPR.	INHALT CA. VOLUME APPR.	VE PU
153 031 58	40	31	35,0	17,5	25,5	1
153 042 58	40	42	34,5	18,5	32,0	1
153 060 58	40	60	35,0	19,5	47,0	1





RILLEN
 PFLANZTOPF KUBUS QUADRAT
 GROOVED PLANTER KUBUS SQUARE

RILLEN PFLANZTOPF KUBUS QUADRAT
 GROOVED PLANTER KUBUS SQUARE



SEITE 234
 PAGE



● anthrazit / anthracite (38)

ART.-NR. MODEL	AUSSENMASS CA. OUTSIDE DIMENSION APPR.	HÖHE CA. HEIGHT APPR.	INNENMASS CA. INSIDE DIMENSION APPR.	HÖHE INNEN CA. HEIGHT INSIDE APPR.	INHALT CA. VOLUME APPR.	VE PU
165 030 38	30 x 30	26	22 x 22	22	10	1
165 040 38	40 x 40	33	31 x 31	28	26	1
165 050 38	50 x 50	40	42 x 42	34	58	1
165 060 38	60 x 60	47	53 x 53	46	151	1

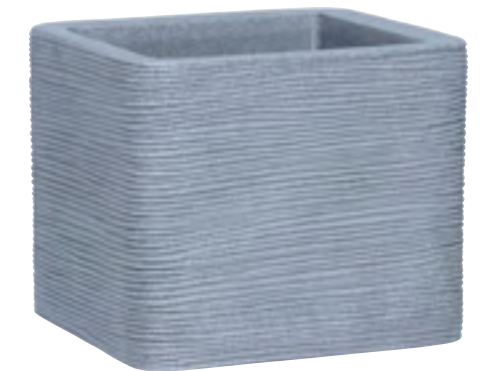

● betonfarbe / concrete colour (58)

ART.-NR. MODEL	AUSSENMASS CA. OUTSIDE DIMENSION APPR.	HÖHE CA. HEIGHT APPR.	INNENMASS CA. INSIDE DIMENSION APPR.	HÖHE INNEN CA. HEIGHT INSIDE APPR.	INHALT CA. VOLUME APPR.	VE PU
165 030 58	30 x 30	26	22 x 22	22	10	1
165 040 58	40 x 40	33	31 x 31	28	26	1
165 050 58	50 x 50	40	42 x 42	34	58	1
165 060 58	60 x 60	47	53 x 53	46	151	1



RILLEN

TROG
GROOVED TROUGH



RILLEN TROG GROOVED TROUGH



● anthrazit / anthracite (38)

ART.-NR. MODEL	AUSSENMASS CA. OUTSIDE DIMENSION APPR.	HÖHE CA. HEIGHT APPR.	INNENMASS CA. INSIDE DIMENSION APPR.	BODENMASS CA. GROUND DIMENSION APPR.	INHALT CA. VOLUME APPR.	VE PU
159 080 38	80 x 40	34	75,0 x 34,5	63,5 x 24,0	79	1

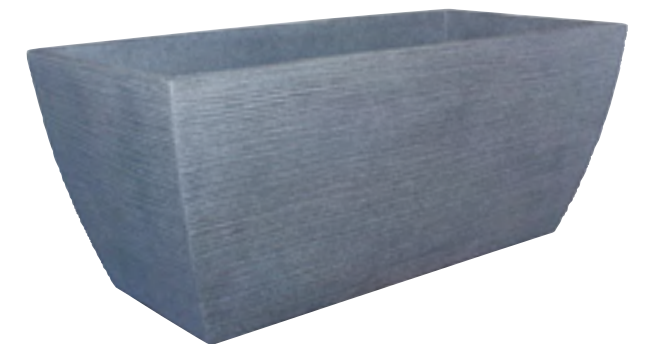

● betonfarbe / concrete colour (58)

ART.-NR. MODEL	AUSSENMASS CA. OUTSIDE DIMENSION APPR.	HÖHE CA. HEIGHT APPR.	INNENMASS CA. INSIDE DIMENSION APPR.	BODENMASS CA. GROUND DIMENSION APPR.	INHALT CA. VOLUME APPR.	VE PU
159 080 58	80 x 40	34	75,0 x 34,5	63,5 x 24,0	79	1





RILLEN

SCHALE QUADRAT
GROOVED BOWL SQUARE

RILLEN SCHALE QUADRAT GROOVED BOWL SQUARE

● anthrazit / anthracite (38)



ART.-NR. MODEL	AUSSENMASS CA. OUTSIDE DIMENSION APPR.	HÖHE CA. HEIGHT APPR.	INNENMASS CA. INSIDE DIMENSION APPR.	BODENMASS CA. GROUND DIMENSION APPR.	INHALT CA. VOLUME APPR.	VE PU
173 052 38	52 x 52	25	47 x 47	30 x 30	43	1

● betonfarbe / concrete colour (58)



ART.-NR. MODEL	AUSSENMASS CA. OUTSIDE DIMENSION APPR.	HÖHE CA. HEIGHT APPR.	INNENMASS CA. INSIDE DIMENSION APPR.	BODENMASS CA. GROUND DIMENSION APPR.	INHALT CA. VOLUME APPR.	VE PU
173 052 58	52 x 52	25	47 x 47	30 x 30	43	1

RILLEN SCHALE RUND GROOVED BOWL ROUND

● anthrazit / anthracite (38)



ART.-NR. MODEL	AUSSENMASS CA. Ø OUTSIDE DIMENSION APPR.	HÖHE CA. HEIGHT APPR.	INNENMASS CA. Ø INSIDE DIMENSION APPR.	BODENMASS CA. Ø GROUND DIMENSION APPR.	INHALT CA. VOLUME APPR.	VE PU
172 060 38	60	28	54	34	59	1

● betonfarbe / concrete colour (58)



ART.-NR. MODEL	AUSSENMASS CA. Ø OUTSIDE DIMENSION APPR.	HÖHE CA. HEIGHT APPR.	INNENMASS CA. Ø INSIDE DIMENSION APPR.	BODENMASS CA. Ø GROUND DIMENSION APPR.	INHALT CA. VOLUME APPR.	VE PU
172 060 58	60	28	54	34	59	1



RILLEN

SCHALE RUND
GROOVED BOWL ROUND



Serie Stone

Stone range



UNSERE PFLANZGEFÄSSE DER SERIE STONE /
OUR PLANTERS IN THE STONE RANGE:



STONE PFLANZTOPF RUND
STONE PLANTER ROUND



Seite / Page 150



STONE KUBUS
STONE KUBUS



Seite / Page 152



STONE PFLANZTOPF QUADRAT
STONE PLANTER SQUARE



Seite / Page 154



STONE SCHALE OVAL
STONE BOWL OVAL



Seite / Page 155



Außenmaß Outside dimension
Innenmaß Inside dimension



Bodenmaß Ground dimension

PRODUKTE AUF DIESER SEITE / PRODUCTS ON THIS PAGE:
STONE Kubus, Stone Pflanztopf quadrat in anthrazit / STONE Kubus, Stone Planter square in anthracite

STONE

PFLANZTOPF RUND
PLANTER ROUND



STONE PFLANZTOPF RUND STONE PLANTER ROUND



● anthrazit / anthracite (38)

ART.-NR. MODEL	AUSSENMASS CA. Ø OUTSIDE DIMENSION APPR.	HÖHE CA. HEIGHT APPR.	INNENMASS CA. Ø INSIDE DIMENSION APPR.	BODENMASS CA. Ø GROUND DIMENSION APPR.	INHALT CA. VOLUME APPR.	VE PU
161 040 38	40	32	35,0	18	25	1
161 050 38	50	38	42,5	28	49	1
161 060 38	60	45	52,5	35	90	1
161 080 38	80	57	70,0	48	185	1



● betonfarbe / concrete colour (58)

ART.-NR. MODEL	AUSSENMASS CA. Ø OUTSIDE DIMENSION APPR.	HÖHE CA. HEIGHT APPR.	INNENMASS CA. Ø INSIDE DIMENSION APPR.	BODENMASS CA. Ø GROUND DIMENSION APPR.	INHALT CA. VOLUME APPR.	VE PU
161 040 58	40	32	35,0	18	25	1
161 050 58	50	38	42,5	28	49	1
161 060 58	60	45	52,5	35	90	1
161 080 58	80	57	70,0	48	185	1





STONE
KUBUS
KUBUS

STONE KUBUS
STONE KUBUS



SEITE 236
PAGE



● anthrazit / anthracite (38)

ART.-NR. MODEL	AUSSENMASS CA. OUTSIDE DIMENSION APPR.	HÖHE CA. HEIGHT APPR.	INNENMASS CA. INSIDE DIMENSION APPR.	HÖHE INNEN CA. HEIGHT INSIDE APPR.	INHALT CA. VOLUME APPR.	VE PU
166 030 38	30 x 30	26	22 x 22	22	10	1
166 040 38	40 x 40	33	31 x 31	28	26	1
166 050 38	50 x 50	40	42 x 42	34	37	1
166 060 38	60 x 60	47	53 x 53	46	154	1



● betonfarbe / concrete colour (58)

ART.-NR. MODEL	AUSSENMASS CA. OUTSIDE DIMENSION APPR.	HÖHE CA. HEIGHT APPR.	INNENMASS CA. INSIDE DIMENSION APPR.	HÖHE INNEN CA. HEIGHT INSIDE APPR.	INHALT CA. VOLUME APPR.	VE PU
166 030 58	30 x 30	26	22 x 22	22	10	1
166 040 58	40 x 40	33	31 x 31	28	26	1
166 050 58	50 x 50	40	42 x 42	34	37	1
166 060 58	60 x 60	47	53 x 53	46	154	1



STONE

PFLANZTOPF QUADRAT PLANTER SQUARE



STONE SCHALE OVAL STONE BOWL OVAL



● anthrazit / anthracite (38)

ART.-NR. MODEL	AUSSENMASS CA. OUTSIDE DIMENSION APPR.	HÖHE CA. HEIGHT APPR.	INNENMASS CA. INSIDE DIMENSION APPR.	BODENMASS CA. GROUND DIMENSION APPR.	INHALT CA. VOLUME APPR.	VE PU
162 060 38	60 x 34	23	50,0 x 29,5	31 x 21	24	1
162 070 38	70 x 40	27	62,5 x 35,0	36 x 21	38	1



● betonfarbe / concrete colour (58)

ART.-NR. MODEL	AUSSENMASS CA. OUTSIDE DIMENSION APPR.	HÖHE CA. HEIGHT APPR.	INNENMASS CA. INSIDE DIMENSION APPR.	BODENMASS CA. GROUND DIMENSION APPR.	INHALT CA. VOLUME APPR.	VE PU
162 060 58	60 x 34	23	50,0 x 29,5	31 x 21	24	1
162 070 58	70 x 40	27	62,5 x 35,0	36 x 21	38	1

STONE

SCHALE OVAL BOWL OVAL



STONE PFLANZTOPF QUADRAT STONE PLANTER SQUARE



● anthrazit / anthracite (38)

ART.-NR. MODEL	AUSSENMASS CA. OUTSIDE DIMENSION APPR.	HÖHE CA. HEIGHT APPR.	INNENMASS CA. INSIDE DIMENSION APPR.	BODENMASS CA. GROUND DIMENSION APPR.	INHALT CA. VOLUME APPR.	VE PU
167 040 38	40 x 40	30,5	35 x 35	20 x 20	32	1



● betonfarbe / concrete colour (58)

ART.-NR. MODEL	AUSSENMASS CA. OUTSIDE DIMENSION APPR.	HÖHE CA. HEIGHT APPR.	INNENMASS CA. INSIDE DIMENSION APPR.	BODENMASS CA. GROUND DIMENSION APPR.	INHALT CA. VOLUME APPR.	VE PU
167 040 58	40 x 40	30,5	35 x 35	20 x 20	32	1



Serie Napoli

Napoli range



UNSERE PFLANZGEFÄSSE DER SERIE NAPOLI /
OUR PLANTERS IN THE NAPOLI RANGE:



NAPOLI PFLANZTOPF
NAPOLI PLANTER



Seite / Page 158



NAPOLI JARDINIERE
NAPOLI PLANTER



Seite / Page 160



NAPOLI SCHALE
NAPOLI BOWL



Seite / Page 161

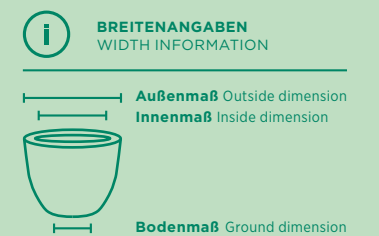

PRODUKTE AUF DIESER SEITE / PRODUCTS ON THIS PAGE:
NAPOLI Pflanztopf in betonfarbe / NAPOLI Planter in concrete colour



NAPOLI

PFLANZTOPF
PLANTER

NAPOLI PFLANZTOPF NAPOLI PLANTER



● anthrazit / anthracite (38)

ART.-NR. MODEL	AUSSENMASS CA. Ø OUTSIDE DIMENSION APPR.	HÖHE CA. HEIGHT APPR.	INNENMASS CA. Ø INSIDE DIMENSION APPR.	BODENMASS CA. Ø GROUND DIMENSION APPR.	INHALT CA. VOLUME APPR.	VE PU
130 030 38	29	29	24	20	10	1
130 040 38	39	32	35	27	24	1
130 050 38	47	39	40	29	43	1
130 060 38	58	48	50	36	81	1

STRUKTUR

Marcella und Napoli haben unterschiedliche Oberflächenstrukturen. Marcella and Napoli have different surface structures.



ZUBEHÖR
ACCESSORIES

MARCELLA UNTERSETZER RUND

MARCELLA SAUCER ROUND



SEITE 206
PAGE



ART.-NR. PFLANZTOPF MODEL PLANTER	ART.-NR. UNTERSETZER MODEL SAUCER
130 030 ..	124 030 ..
130 040 ..	124 038 ..
130 050 ..	124 043 ..
130 060 ..	124 048 ..



● betonfarbe / concrete colour (59)

ART.-NR. MODEL	AUSSENMASS CA. Ø OUTSIDE DIMENSION APPR.	HÖHE CA. HEIGHT APPR.	INNENMASS CA. Ø INSIDE DIMENSION APPR.	BODENMASS CA. Ø GROUND DIMENSION APPR.	INHALT CA. VOLUME APPR.	VE PU
130 030 59	29	29	24	20	10	1
130 040 59	39	32	35	27	24	1
130 050 59	47	39	40	29	43	1
130 060 59	58	48	50	36	81	1



NAPOLI

JARDINIERE PLANTER



NAPOLI SCHALE NAPOLI BOWL



● anthrazit / anthracite (38)

ART.-NR. MODEL	AUSSENMASS CA. Ø OUTSIDE DIMENSION APPR.	HÖHE CA. HEIGHT APPR.	INNENMASS CA. Ø INSIDE DIMENSION APPR.	BODENMASS CA. Ø GROUND DIMENSION APPR.	INHALT CA. VOLUME APPR.	VE PU
171 030 38	29	12	26,5	22	5	1
171 040 38	39	16	35,5	29	13	1



● betonfarbe / concrete colour (59)

ART.-NR. MODEL	AUSSENMASS CA. Ø OUTSIDE DIMENSION APPR.	HÖHE CA. HEIGHT APPR.	INNENMASS CA. Ø INSIDE DIMENSION APPR.	BODENMASS CA. Ø GROUND DIMENSION APPR.	INHALT CA. VOLUME APPR.	VE PU
171 030 59	29	12	26,5	22	5	1
171 040 59	39	16	35,5	29	13	1

NAPOLI

SCHALE BOWL



NAPOLI JARDINIERE NAPOLI PLANTER

● anthrazit / anthracite (38)



ART.-NR. MODEL	AUSSENMASS CA. OUTSIDE DIMENSION APPR.	HÖHE CA. HEIGHT APPR.	INNENMASS CA. INSIDE DIMENSION APPR.	BODENMASS CA. GROUND DIMENSION APPR.	INHALT CA. VOLUME APPR.	VE PU
170 060 38	59,0x19,5	16	56,5x17,5	51,5x12,0	11	1

● betonfarbe / concrete colour (59)



ART.-NR. MODEL	AUSSENMASS CA. OUTSIDE DIMENSION APPR.	HÖHE CA. HEIGHT APPR.	INNENMASS CA. INSIDE DIMENSION APPR.	BODENMASS CA. GROUND DIMENSION APPR.	INHALT CA. VOLUME APPR.	VE PU
170 060 59	59,0x19,5	16	56,5x17,5	51,5x12,0	11	1



Serie Rimini

Rimini range



UNSERE PFLANZGEFÄSSE DER SERIE RIMINI /
OUR PLANTERS IN THE RIMINI RANGE:



RIMINI PFLANZTOPF
RIMINI PLANTER



Seite / Page 164



RIMINI JARDINIERE
RIMINI PLANTER



Seite / Page 166



RIMINI SCHALE
RIMINI BOWL



Seite / Page 167

i BREITENANGABEN
WIDTH INFORMATION

Außenmaß Outside dimension
Innenmaß Inside dimension



Bodenmaß Ground dimension

PRODUKTE AUF DIESER SEITE / PRODUCTS ON THIS PAGE:
RIMINI Pflanztopf in anthrazit / RIMINI Planter in anthracite



RIMINI

PFLANZTOPF
PLANTER

RIMINI PFLANZTOPF RIMINI PLANTER



● anthrazit / anthracite (38)

ART.-NR. MODEL	AUSSENMASS CA. Ø OUTSIDE DIMENSION APPR.	HÖHE CA. HEIGHT APPR.	INNENMASS CA. Ø INSIDE DIMENSION APPR.	BODENMASS CA. Ø GROUND DIMENSION APPR.	INHALT CA. VOLUME APPR.	VE PU
143 030 38	30	23,0	26,5	18	9,5	1
143 035 38	35	26,5	30,0	21	16,5	1
143 040 38	40	31,0	35,0	24	24,0	1
143 045 38	45	34,5	39,0	27	33,5	1
143 050 38	50	38,5	42,0	30	49,0	1
143 060 38	60	45,5	52,5	36	85,5	1



● taupe / taupe (40)

ART.-NR. MODEL	AUSSENMASS CA. Ø OUTSIDE DIMENSION APPR.	HÖHE CA. HEIGHT APPR.	INNENMASS CA. Ø INSIDE DIMENSION APPR.	BODENMASS CA. Ø GROUND DIMENSION APPR.	INHALT CA. VOLUME APPR.	VE PU
143 030 40	30	23,0	26,5	18	9,5	1
143 035 40	35	26,5	30,0	21	16,5	1
143 040 40	40	31,0	35,0	24	24,0	1
143 045 40	45	34,5	39,0	27	33,5	1
143 050 40	50	38,5	42,0	30	49,0	1
143 060 40	60	45,5	52,5	36	85,5	1

STRUKTUR

Marcella und Rimini haben unterschiedliche Oberflächenstrukturen. Marcella and Rimini have different surface structures.

Beispielbild / Example image



ZUBEHÖR
ACCESSORIES

MARCELLA UNTERSETZER RUND MARCELLA SAUCER ROUND



SEITE 206
PAGE



ART.-NR. PFLANZTOPF MODEL PLANTER	ART.-NR. UNTERSETZER MODEL SAUCER
143 030 ..	124 026 ..
143 035 ..	124 030 ..
143 040 ..	124 035 ..
143 045 ..	124 038 ..
143 050 ..	124 048 ..
143 060 ..	124 048 ..





RIMINI

JARDINIERE
PLANTER

RIMINI JARDINIERE

RIMINI PLANTER

● anthrazit / anthracite (38)



ART.-NR. MODEL	AUSSENMASS CA. OUTSIDE DIMENSION APPR.	HÖHE CA. HEIGHT APPR.	INNENMASS CA. INSIDE DIMENSION APPR.	BODENMASS CA. GROUND DIMENSION APPR.	INHALT CA. VOLUME APPR.	VE PU
156 060 38	59,5x25,5	19	54,0x20,5	36x15	14,3	1

● taupe / taupe (40)



ART.-NR. MODEL	AUSSENMASS CA. OUTSIDE DIMENSION APPR.	HÖHE CA. HEIGHT APPR.	INNENMASS CA. INSIDE DIMENSION APPR.	BODENMASS CA. GROUND DIMENSION APPR.	INHALT CA. VOLUME APPR.	VE PU
156 060 40	59,5x25,5	19	54,0x20,5	36x15	14,3	1

RIMINI SCHALE

RIMINI BOWL



● anthrazit / anthracite (38)

ART.-NR. MODEL	AUSSENMASS CA. Ø OUTSIDE DIMENSION APPR.	HÖHE CA. HEIGHT APPR.	INNENMASS CA. Ø INSIDE DIMENSION APPR.	BODENMASS CA. Ø GROUND DIMENSION APPR.	INHALT CA. VOLUME APPR.	VE PU
155 040 38	39,5	17	34	24	15,5	1

● taupe / taupe (40)



ART.-NR. MODEL	AUSSENMASS CA. Ø OUTSIDE DIMENSION APPR.	HÖHE CA. HEIGHT APPR.	INNENMASS CA. Ø INSIDE DIMENSION APPR.	BODENMASS CA. Ø GROUND DIMENSION APPR.	INHALT CA. VOLUME APPR.	VE PU
155 040 40	39,5	17	34	24	15,5	1



RIMINI

SCHALE
BOWL





Naturdesign

Nature design

PRODUKTE AUF DIESER SEITE / PRODUCTS ON THIS PAGE:
 PALERMO Pflanztopf in impruneta / PALERMO Planter in impruneta

UNSERE NATURDESIGN-PFLANZGEFÄSSE / OUR PLANTERS IN NATURE DESIGN:



MEGALOS PFLANZTOPF
 MEGALOS PLANTER
 ● ● ●

Seite / Page 170



PALERMO PFLANZTOPF
 PALERMO PLANTER
 ● ●

Seite / Page 172



MILANO PFLANZTOPF
 MILANO PLANTER
 ● ●

Seite / Page 174



PARMA PFLANZGEFÄSS
 PARMA PLANTER
 ● ●

Seite / Page 176



RAVENNA PFLANZTOPF
 RAVENNA PLANTER
 ● ●

Seite / Page 178



LIVORNO VASE
 LIVORNO VASE
 ●

Seite / Page 180



KUGELTOPF
 ROUND POT
 ● ●

Seite / Page 181

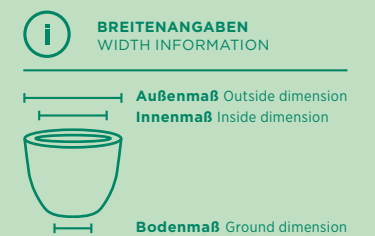

MEGALOS

PFLANZTOPF
PLANTER



MEGALOS PFLANZTOPF MEGALOS PLANTER



● impruneta / impruneta (37)

ART.-NR. MODEL	AUSSENMASS CA. Ø OUTSIDE DIMENSION APPR.	HÖHE CA. HEIGHT APPR.	INNENMASS CA. Ø INSIDE DIMENSION APPR.	BODENMASS CA. Ø GROUND DIMENSION APPR.	INHALT CA. VOLUME APPR.	VE PU
120 080 37	80	53	72	60	200	1
120 098 37	98	59	90	69	310	1
120 122 37	122	73	114	86	670	1



● anthrazit / anthracite (38)

ART.-NR. MODEL	AUSSENMASS CA. Ø OUTSIDE DIMENSION APPR.	HÖHE CA. HEIGHT APPR.	INNENMASS CA. Ø INSIDE DIMENSION APPR.	BODENMASS CA. Ø GROUND DIMENSION APPR.	INHALT CA. VOLUME APPR.	VE PU
120 080 38	80	53	72	60	200	1
120 098 38	98	59	90	69	310	1
120 122 38	122	73	114	86	670	1



● hellgrau / light grey (60)

ART.-NR. MODEL	AUSSENMASS CA. Ø OUTSIDE DIMENSION APPR.	HÖHE CA. HEIGHT APPR.	INNENMASS CA. Ø INSIDE DIMENSION APPR.	BODENMASS CA. Ø GROUND DIMENSION APPR.	INHALT CA. VOLUME APPR.	VE PU
120 080 60	80	53	72	60	200	1
120 098 60	98	59	90	69	310	1
120 122 60	122	73	114	86	670	1





PALERMO

PFLANZTOPF
PLANTER

PALERMO PFLANZTOPF
PALERMO PLANTER



SEITE 236
PAGE



● impruneta / impruneta (37)

ART.-NR. MODEL	AUSSENMASS CA. Ø OUTSIDE DIMENSION APPR.	HÖHE CA. HEIGHT APPR.	INNENMASS CA. Ø INSIDE DIMENSION APPR.	BODENMASS CA. Ø GROUND DIMENSION APPR.	INHALT CA. VOLUME APPR.	VE PU
121 030 37	30	22	25	23	8,5	1
121 035 37	35	26	29	26	13,0	1
121 040 37	40	30	34	30	20,5	1
121 045 37	45	34	38	34	31,0	1
121 050 37	50	38	42	37	42,0	1
121 060 37	60	47	51	45	74,0	1
121 070 37	70	52	59	54	117,0	1
121 080 37	80	60	68	61	179,0	1
121 100 37	100	75	84	75	367,0	1
121 120 37	120	90	101	89	723,0	1



● anthrazit / anthracite (38)

ART.-NR. MODEL	AUSSENMASS CA. Ø OUTSIDE DIMENSION APPR.	HÖHE CA. HEIGHT APPR.	INNENMASS CA. Ø INSIDE DIMENSION APPR.	BODENMASS CA. Ø GROUND DIMENSION APPR.	INHALT CA. VOLUME APPR.	VE PU
121 030 38	30	22	25	23	8,5	1
121 035 38	35	26	29	26	13,0	1
121 040 38	40	30	34	30	20,5	1
121 045 38	45	34	38	34	31,0	1
121 050 38	50	38	42	37	42,0	1
121 060 38	60	47	51	45	74,0	1
121 070 38	70	52	59	54	117,0	1
121 080 38	80	60	68	61	179,0	1
121 100 38	100	75	84	75	367,0	1
121 120 38	120	90	101	89	723,0	1



Beispielbild / Example image

MARCELLA UNTERSETZER RUND
MARCELLA SAUCER ROUND



SEITE 206
PAGE



ART.-NR. PFLANZTOPF MODEL PLANTER	ART.-NR. UNTERSETZER MODEL SAUCER
121 030 ..	124 030 ..
121 035 ..	124 035 ..
121 040 ..	124 038 ..
121 045 ..	124 043 ..
121 050 ..	124 048 ..
121 060 ..	124 056 ..
121 070 ..	124 063 ..
121 080 ..	-
121 100 ..	-
121 120 ..	-



ZUBEHÖR
ACCESSORIES





MILANO

PFLANZTOPF
PLANTER

MILANO PFLANZTOPF MILANO PLANTER



SEITE 237
PAGE



● impruneta / impruneta (37)

ART.-NR. MODEL	AUSSENMASS CA. Ø OUTSIDE DIMENSION APPR.	HÖHE CA. HEIGHT APPR.	INNENMASS CA. Ø INSIDE DIMENSION APPR.	BODENMASS CA. Ø GROUND DIMENSION APPR.	INHALT CA. VOLUME APPR.	VE PU
110 030 37	29,5	23,5	24	17,5	8,0	5
110 035 37	34,0	27,5	28	20,0	12,5	5
110 040 37	38,0	32,0	31	22,5	19,0	5
110 045 37	42,5	36,0	36	26,0	27,5	5
110 055 37	52,0	42,5	45	33,5	53,0	5
110 060 37	59,0	46,5	52	34,0	68,5	1
110 070 37	70,0	57,0	60	42,0	110,5	1



● anthrazit / anthracite (38)

ART.-NR. MODEL	AUSSENMASS CA. Ø OUTSIDE DIMENSION APPR.	HÖHE CA. HEIGHT APPR.	INNENMASS CA. Ø INSIDE DIMENSION APPR.	BODENMASS CA. Ø GROUND DIMENSION APPR.	INHALT CA. VOLUME APPR.	VE PU
110 030 38	29,5	23,5	24	17,5	8,0	5
110 035 38	34,0	27,5	28	20,0	12,5	5
110 040 38	38,0	32,0	31	22,5	19,0	5
110 045 38	42,5	36,0	36	26,0	27,5	5
110 055 38	52,0	42,5	45	33,5	53,0	5
110 060 38	59,0	46,5	52	34,0	68,5	1
-	-	-	-	-	-	-



MARCELLA UNTERSETZER RUND MARCELLA SAUCER ROUND



SEITE 206
PAGE



ART.-NR. PFLANZTOPF MODEL PLANTER	ART.-NR. UNTERSETZER MODEL SAUCER
110 030 ..	124 026 ..
110 035 ..	124 030 ..
110 040 ..	124 035 ..
110 045 ..	124 038 ..
110 055 ..	124 043 ..
110 060 ..	124 043 ..
110 070 ..	124 056 ..



ZUBEHÖR
ACCESSORIES



PARMA

PFLANZGEFÄSS
PLANTER



PARMA PFLANZGEFÄSS PARMA PLANTER



● impruneta / impruneta (37)

ART.-NR. MODEL	AUSSENMASS CA. OUTSIDE DIMENSION APPR.	HÖHE CA. HEIGHT APPR.	INNENMASS CA. INSIDE DIMENSION APPR.	BODENMASS CA. GROUND DIMENSION APPR.	INHALT CA. VOLUME APPR.	VE PU
122 040 37	40 x 40	34	35 x 35	26 x 26	29	1
122 050 37	50 x 50	43	44 x 44	34 x 34	62	1



BIANCA UNTERSETZER ECKIG BIANCA SAUCER SQUARE



SEITE 208
PAGE



ART.-NR. PFLANZGEFÄSS MODEL PLANTER	ART.-NR. UNTERSETZER MODEL SAUCER
122 040 ..	125 036 ..
122 050 ..	125 043 ..



ZUBEHÖR
ACCESSORIES



● anthrazit / anthracite (38)

ART.-NR. MODEL	AUSSENMASS CA. OUTSIDE DIMENSION APPR.	HÖHE CA. HEIGHT APPR.	INNENMASS CA. INSIDE DIMENSION APPR.	BODENMASS CA. GROUND DIMENSION APPR.	INHALT CA. VOLUME APPR.	VE PU
122 040 38	40 x 40	34	35 x 35	26 x 26	29	1
122 050 38	50 x 50	43	44 x 44	34 x 34	62	1





RAVENNA

PFLANZTOPF
PLANTER

RAVENNA PFLANZTOPF RAVENNA PLANTER



● anthrazit / anthracite (38)

ART.-NR. MODEL	AUSSENMASS CA. OUTSIDE DIMENSION APPR.	HÖHE CA. HEIGHT APPR.	INNENMASS CA. INSIDE DIMENSION APPR.	BODENMASS CA. GROUND DIMENSION APPR.	INHALT CA. VOLUME APPR.	VE PU
146 030 38	30 x 30	25,5	26,5 x 26,5	19 x 19	15,0	1
146 040 38	40 x 40	34,0	35,0 x 35,0	26 x 26	36,5	1
146 050 38	50 x 50	42,5	43,0 x 43,0	32 x 32	72,0	1

STRUKTUR

Marcella und Ravenna haben unterschiedliche Oberflächenstrukturen.
Marcella and Ravenna have different surface structures.



Beispielbild / Example image



ZUBEHÖR
ACCESSORIES

BIANCA UNTERSETZER ECKIG

BIANCA SAUCER SQUARE



SEITE 208
PAGE



ART.-NR. PFLANZTOPF MODEL PLANTER	ART.-NR. UNTERSETZER MODEL SAUCER
146 030 ..	125 027 ..
146 040 ..	125 036 ..
146 050 ..	125 043 ..

● taupe / taupe (40)



ART.-NR. MODEL	AUSSENMASS CA. OUTSIDE DIMENSION APPR.	HÖHE CA. HEIGHT APPR.	INNENMASS CA. INSIDE DIMENSION APPR.	BODENMASS CA. GROUND DIMENSION APPR.	INHALT CA. VOLUME APPR.	VE PU
146 030 40	30 x 30	25,5	26,5 x 26,5	19 x 19	15,0	1
146 040 40	40 x 40	34,0	35,0 x 35,0	26 x 26	36,5	1
146 050 40	50 x 50	42,5	43,0 x 43,0	32 x 32	72,0	1





LIVORNO

VASE
VASE

LIVORNO VASE

LIVORNO VASE



● anthrazit / anthracite (38)

ART.-NR. MODEL	AUSSENMASS CA. OUTSIDE DIMENSION APPR.	HÖHE CA. HEIGHT APPR.	INNENMASS CA. INSIDE DIMENSION APPR.	BODENMASS CA. GROUND DIMENSION APPR.	INHALT CA. VOLUME APPR.	VE PU
129 035 38	24x24	35	20x20	15x15	12	1
129 045 38	27x27	45	22x22	15x15	17	1
129 055 38	35x35	55	30x30	22x22	40	1
129 063 38	40x40	63	34x34	24x24	67	1

KUGELTOPF

ROUND POT



● anthrazit / anthracite (38)

ART.-NR. MODEL	AUSSENMASS CA. Ø OUTSIDE DIMENSION APPR.	HÖHE CA. HEIGHT APPR.	INNENMASS CA. Ø INSIDE DIMENSION APPR.	BODENMASS CA. Ø GROUND DIMENSION APPR.	INHALT CA. VOLUME APPR.	VE PU
168 040 38	40	34	24	21	30	1



● betonfarbe / concrete colour (58)

ART.-NR. MODEL	AUSSENMASS CA. Ø OUTSIDE DIMENSION APPR.	HÖHE CA. HEIGHT APPR.	INNENMASS CA. Ø INSIDE DIMENSION APPR.	BODENMASS CA. Ø GROUND DIMENSION APPR.	INHALT CA. VOLUME APPR.	VE PU
168 040 58	40	34	24	21	30	1



KUGELTOPF

ROUND POT





Sonstiges

Übersicht / Overview

Flexikorb	184
Flexible basket	
Dropman	185
Dropman	
Grabvasen	186
Grave vases	
Kanister	188
Canister	

FLEXIKORB

FLEXIBLE BASKET



FLEXIKORB
FLEXIBLE BASKET



● dunkelgrün / dark green (11)

ART.-NR. MODEL	GRÖSSE CA. Ø SIZE APPR.	HÖHE CA. HEIGHT APPR.	INHALT CA. VOLUME APPR.	VE PU
380 051 11	51	38	30	10



**SAMMELGEFÄSS
FÜR GARTENABFÄLLE**
GARDEN WASTE
CONTAINER

DROPMAN IM DISPLAY
DROPMAN IN DISPLAY



verschiedene Farben / different colours (99)

ART.-NR. MODEL	HÖHE GESAMT CA. HEIGHT TOTAL APPR.	HÖHE TONKEGEL CA. HEIGHT CLAY CONE APPR.	BREITE CA. WIDTH APPR.	INHALT CA. VOLUME APPR.	DISPLAYGRÖSSE CA. DISPLAY SIZE APPR.	VE PU
494 014 99	14,5	5,0	5	0,07	40,0x25,5x18,5	25
494 019 99	19,5	6,5	7	0,2	40,0x29,5x24,5	16

DROPMAN

WASSERRESERVOIR
WATER CONTAINER





GRABVASEN

GRAVE VASES

GRABVASEN GRAVE VASES



● dunkelgrün / dark green (11)

ART.-NR. MODEL	HÖHE CA. HEIGHT APPR.	GRÖSSE CA. Ø SIZE APPR.	INHALT CA. VOLUME APPR.	VE PU
870 026 11	26	11,0	0,7	5
870 031 11	31	11,5	0,8	5
870 037 11	37	12,0	1,1	5
870 042 11	42	12,5	1,3	5



● anthrazit / anthracite (38)

ART.-NR. MODEL	HÖHE CA. HEIGHT APPR.	GRÖSSE CA. Ø SIZE APPR.	INHALT CA. VOLUME APPR.	VE PU
870 026 38	26	11,0	0,7	5
870 031 38	31	11,5	0,8	5
870 037 38	37	12,0	1,1	5
-	-	-	-	-



KANISTER

CANISTER



UNSERE KANISTER SIND ZERTIFIZIERT UND LEBENSMITTELECHT.
THIS CANISTER IS ALSO SUITABLE FOR FOOD AND THEREFORE FOOD SAFE.

KANISTER CANISTER



farblos / colourless (05)

ART.-NR. MODEL	INHALT CA. VOLUME APPR.	VE PU
202 005 05	5	10
202 010 05	10	10
202 020 05	20	10

KANISTER MIT HAHN CANISTER WITH POURER



farblos / colourless (05)

ART.-NR. MODEL	INHALT CA. VOLUME APPR.	VE PU
205 010 05	10	10
205 020 05	20	10

ERSATZTEIL
SPARE PART

AUSLAUFHAHN FÜR KANISTER POURER FOR CANISTER

ART.-NR. 900 205 03
MODEL

SEITE 212
PAGE





Zubehör

Übersicht / Overview

Untersetzer Blumenkästen ____ 192
Flower box saucers

Halter Blumenkästen _____ 196
Flower box brackets

Untersetzer Töpfe Outdoor ____ 200
Flower pot saucers

Zubehör für Orchideen _____ 210
Accessories for orchids

Ersatzteile _____ 212
Spare parts



BLUMENKASTEN- UNTERSETZER

FLOWER BOX SAUCERS

STANDARD UNTERSETZER STANDARD SAUCER

terracotta /
terracotta (06)



ART.-NR.
MODEL

804 040 06
804 050 06
804 060 06
804 080 06
804 100 06

braun /
brown (08)



ART.-NR.
MODEL

804 040 08
804 050 08
804 060 08
804 080 08
804 100 08

weiß /
white (10)



ART.-NR.
MODEL

804 040 10
804 050 10
804 060 10
804 080 10
804 100 10

dunkelgrün /
dark green (11)

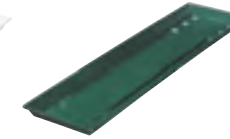

ART.-NR.
MODEL

804 040 11
804 050 11
804 060 11
804 080 11
804 100 11

L x B x H CA.
L x W x H APPR. VE PU EUROPALETTE*
EURO PALLET*

40 x 15,5 x 3 10
50 x 15,5 x 3 10
60 x 15,5 x 3 10 1200
80 x 15,5 x 3 10 1050
100 x 15,5 x 3 10 750

anthrazit /
anthracite (38)

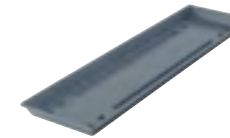

ART.-NR.
MODEL

804 040 38
804 050 38
804 060 38
804 080 38
804 100 38

betonfarbe /
concrete colour (59)



ART.-NR.
MODEL

804 040 59
-
804 060 59
804 080 59
804 100 59

L x B x H CA.
L x W x H APPR. VE PU EUROPALETTE*
EURO PALLET*

40 x 15,5 x 3 10
50 x 15,5 x 3 10
60 x 15,5 x 3 10 1200
80 x 15,5 x 3 10 1050
100 x 15,5 x 3 10 750

i STANDARD UNTERSETZER NICHT ERHÄLTICH IN FARBE PISTAZIE
STANDARD SAUCER NOT AVAILABLE IN THE COLOUR PISTACHIO

+ PASSEND ZU:
MATCHES WITH:

STANDARD
BLUMENKASTEN
STANDARD
FLOWER BOX



ART.-NR. 803 ... SEITE 58
MODEL PAGE

ART.-NR. BLUMENKASTEN MODEL FLOWER BOX	ART.-NR. UNTERSETZER MODEL SAUCER
803 040 ..	804 040 ..
803 050 ..	804 050 ..
803 060 ..	804 060 ..
803 080 ..	804 080 ..
803 100 ..	804 100 ..



TOSCANA UNTERSETZER
TOSCANA SAUCER

terracotta /
terracotta (06)

anthrazit /
anthracite (38)



ART.-NR. MODEL	ART.-NR. MODEL	L x B x H CA. L x W x H APPR.	VE PU
842 060 06	842 060 38	60 x 14 x 2,5	10
842 080 06	842 080 38	80 x 14 x 2,5	10
842 100 06	842 100 38	100 x 14 x 2,5	10

PASSEND ZU:
MATCHES WITH:

TOSCANA



ART.-NR. 822 ...
MODEL

SEITE 60
PAGE

ART.-NR. BLUMENKASTEN MODEL FLOWER BOX	ART.-NR. UNTERSETZER MODEL SAUCER
822 060 ..	842 060 ..
822 080 ..	842 080 ..
822 100 ..	842 100 ..

AQUA TOSCANA



ART.-NR. 825 ...
MODEL

SEITE 74
PAGE

ART.-NR. BLUMENKASTEN MODEL FLOWER BOX	ART.-NR. UNTERSETZER MODEL SAUCER
825 060 ..	842 060 ..
825 080 ..	842 080 ..
825 100 ..	842 100 ..

BLUMENKASTEN-UNTERSETZER - GROSSE AUSFÜHRUNG
FLOWER BOX SAUCER - LARGE VERSION

terracotta /
terracotta (06)

braun /
brown (08)

weiß /
white (10)



ART.-NR. MODEL	ART.-NR. MODEL	ART.-NR. MODEL	L x B x H CA. L x W x H APPR.	VE PU	EUROPALETTE* EURO PALLET*
844 060 06	844 060 08	844 060 10	60 x 18 x 3	10	1200
844 080 06	844 080 08	844 080 10	80 x 18 x 3	10	1050
844 100 06	844 100 08	844 100 10	100 x 18 x 3	10	750

dunkelgrün /
dark green (11)

anthrazit /
anthracite (38)

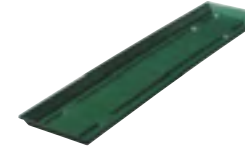

ART.-NR. MODEL	ART.-NR. MODEL	L x B x H CA. L x W x H APPR.	VE PU	EUROPALETTE* EURO PALLET*
844 060 11	844 060 38	60 x 18 x 3	10	1200
844 080 11	844 080 38	80 x 18 x 3	10	1050
844 100 11	844 100 38	100 x 18 x 3	10	750

PASSEND ZU:
MATCHES WITH:

AQUA FLOR



ART.-NR. 801 ...
MODEL

SEITE 80
PAGE

ART.-NR. BLUMENKASTEN MODEL FLOWER BOX	ART.-NR. UNTERSETZER MODEL SAUCER
801 060 ..	844 060 ..
801 080 ..	844 080 ..
801 100 ..	844 100 ..

AQUA ANDALUCIA

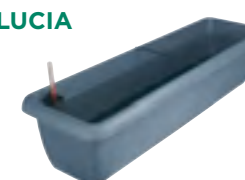

ART.-NR. 828 ...
MODEL

SEITE 76
PAGE

ART.-NR. BLUMENKASTEN MODEL FLOWER BOX	ART.-NR. UNTERSETZER MODEL SAUCER
828 060 ..	844 060 ..
828 080 ..	844 080 ..
828 100 ..	844 100 ..

AQUA GREEN



ART.-NR. 837 ...
MODEL

SEITE 72
PAGE

ART.-NR. BLUMENKASTEN MODEL FLOWER BOX	ART.-NR. UNTERSETZER MODEL SAUCER
837 060 ..	844 060 ..
837 080 ..	844 080 ..
837 100 ..	844 100 ..



BLUMENKASTEN- HALTER

FLOWER BOX BRACKET

Einer für alle - alle für einen: unser Allrounder für alle Blumenkästen - UNIVERSAL Blumenkastenhalter

One for all and all for one: Our all-rounder -
UNIVERSAL flower box bracket

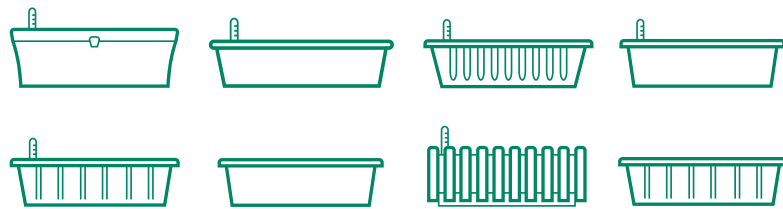

Maximale Flexibilität

Egal ob an der Wand oder am Geländer: Unser Universal Blumenkastenhalter gleicht mit dreifacher Verstellmöglichkeit mühelos unterschiedliche Breiten von Geländern und Kästen aus.

MAXIMUM FLEXIBILITY
Whether a flower box is being mounted on a wall or railing, our universal flower box brackets can handle differences in width with their three adjustment options.

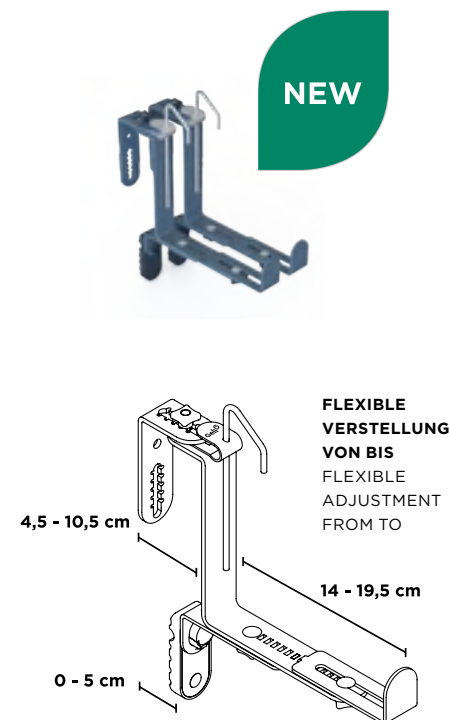

UNIVERSAL BLUMENKASTEN-HALTER TYP U UNIVERSAL FLOWER BOX BRACKET TYPE U

NEW

AUSFÜHRUNG:
3-FACH VERSTELLBAR
DESIGN: TRIPLE ADJUSTMENT

FARBE COLOUR	ART.-NR. MODEL	VE: MONTIERT PU: MOUNTED
06	38 816 000 06	10
10	38 816 000 10	10
38	38 816 000 38	10
59	38 816 000 59	10

+ PASSEND FÜR ALLE UNSERE BLUMENKÄSTEN
MATCHES WITH ALL FLOWER BOXES

AQUA ANDALUCIA

ART.-NR. 828 ...
MODEL
SEITE 76
PAGE

AQUA FLOR

ART.-NR. 801 ...
MODEL
SEITE 80
PAGE

AQUA GREEN

ART.-NR. 837 ...
MODEL
SEITE 72
PAGE

AQUA PALIDO

ART.-NR. 831 ...
MODEL
SEITE 70
PAGE

AQUA TOSCANA

ART.-NR. 825 ...
MODEL
SEITE 74
PAGE

NEO-LINE

ART.-NR. 829 ...
MODEL
SEITE 68
PAGE

STANDARD

ART.-NR. 803 ...
MODEL
SEITE 58
PAGE

TOSCANA

ART.-NR. 822 ...
MODEL
SEITE 60
PAGE

VIVA

ART.-NR. 820 ...
MODEL
SEITE 66
PAGE

BLUMENKASTEN-HALTER RUND TYP G FLOWER BOX BRACKET ROUND TYPE G

ART.-NR. 39 819 001 42
MODEL

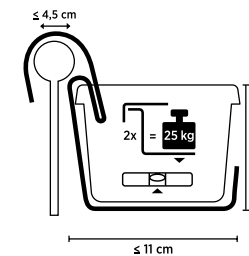

ART.-NR. 39 819 002 42
MODEL

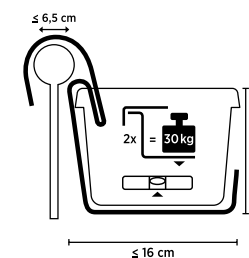

FARBE COLOUR	ART.-NR. MODEL	AUSFÜHRUNG DESIGN	VE: MONTIERT PU: MOUNTED	PASSEND ZU MATCHES WITH
42	39 819 001 42	4,5 cm Ø	50	803 ..
42	39 819 002 42	6,5 cm Ø	50	837 ..

+ PASSEND FÜR BLUMENKASTEN
MATCHES WITH FLOWER BOX

AQUA GREEN

ART.-NR. 837 ...
MODEL
SEITE 72
PAGE

MIT / WITH
39 819 002 42

STANDARD

ART.-NR. 803 ...
MODEL
SEITE 58
PAGE

MIT / WITH
39 819 001 42

Alle Maße in cm / all sizes in cm

BLUMENKASTEN-HALTER TYP A

FLOWER BOX BRACKET TYPE A

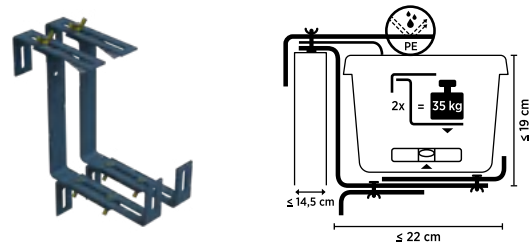

AUSFÜHRUNG: 3-FACH VERSTELLBAR
DESIGN: TRIPLE ADJUSTMENT

FARBE COLOUR	ART.-NR. MODEL	VE: MONTIERT PU: MOUNTED
06	39 818 000 06	10
08	39 818 000 08	10
10	39 818 000 10	10
11	39 818 000 11	10
38	39 818 000 38	10
59	39 818 000 59	10



PASSEND FÜR BLUMENKASTEN
MATCHES WITH FLOWER BOX

AQUA ANDALUCIA
ART.-NR. 828 ...
MODEL
SEITE 76
PAGE

AQUA FLOR
ART.-NR. 801 ...
MODEL
SEITE 80
PAGE

AQUA GREEN
ART.-NR. 837 ...
MODEL
SEITE 72
PAGE

AQUA PALIDO
ART.-NR. 831 ...
MODEL
SEITE 70
PAGE

NEO-LINE
ART.-NR. 829 ...
MODEL
SEITE 68
PAGE

BLUMENKASTEN-HALTER TYP D

FLOWER BOX BRACKET TYPE D

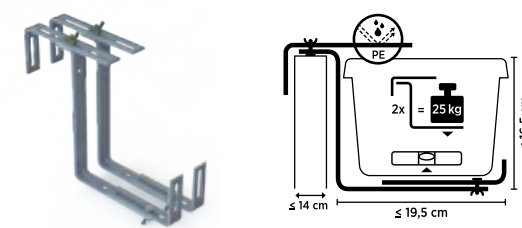

AUSFÜHRUNG: 2-FACH VERSTELLBAR
DESIGN: DOUBLE ADJUSTMENT

FARBE COLOUR	ART.-NR. MODEL	VE: MONTIERT PU: MOUNTED
06	39 817 000 06	10
08	39 817 000 08	10
10	39 817 000 10	10
11	39 817 000 11	10
38	39 817 000 38	10
59	39 817 000 59	10



PASSEND FÜR BLUMENKASTEN
MATCHES WITH FLOWER BOX

STANDARD

ART.-NR. 803 ... SEITE 58
MODEL PAGE

BLUMENKASTEN-HALTER TYP E

FLOWER BOX BRACKET TYPE E

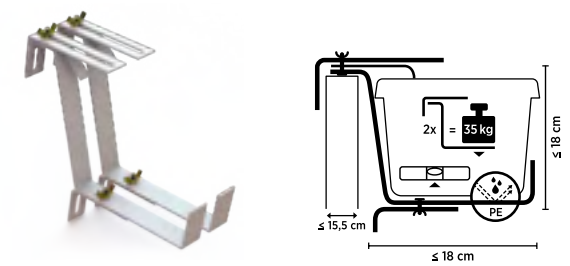

AUSFÜHRUNG: 2-FACH VERSTELLBAR
DESIGN: DOUBLE ADJUSTMENT

FARBE COLOUR	ART.-NR. MODEL	VE: MONTIERT PU: MOUNTED
06	39 814 000 06	10
08	39 814 000 08	10
10	39 814 000 10	10
11	39 814 000 11	10
38	39 814 000 38	10



PASSEND FÜR BLUMENKASTEN
MATCHES WITH FLOWER BOX

AQUA ANDALUCIA
ART.-NR. 828 ...
MODEL
SEITE 76
PAGE

AQUA FLOR
ART.-NR. 801 ...
MODEL
SEITE 80
PAGE

AQUA GREEN
ART.-NR. 837 ...
MODEL
SEITE 72
PAGE

BLUMENKASTEN-HALTER TYP B

FLOWER BOX BRACKET TYPE B

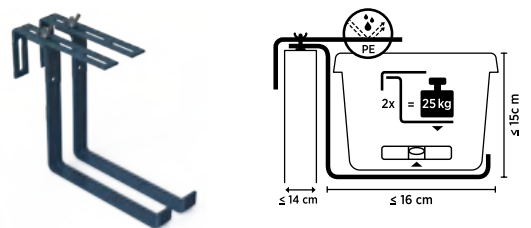

AUSFÜHRUNG: 1-FACH VERSTELLBAR
DESIGN: SIMPLE ADJUSTMENT

FARBE COLOUR	ART.-NR. MODEL	VE: MONTIERT PU: MOUNTED
06	39 811 000 06	10
08	39 811 000 08	10
10	39 811 000 10	10
11	39 811 000 11	10
38	39 811 000 38	10

BLUMENKASTEN-HALTER TYP C

FLOWER BOX BRACKET TYPE C

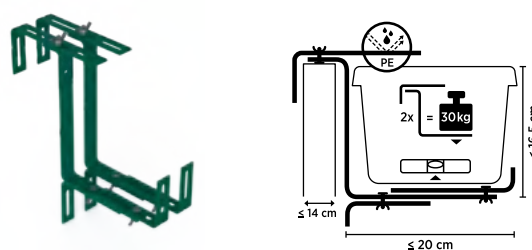

AUSFÜHRUNG: 3-FACH VERSTELLBAR
DESIGN: TRIPLE ADJUSTMENT

FARBE COLOUR	ART.-NR. MODEL	VE: MONTIERT PU: MOUNTED
06	39 813 000 06	10
08	39 813 000 08	10
10	39 813 000 10	10
11	39 813 000 11	10
38	39 813 000 38	10



PASSEND FÜR BLUMENKASTEN
MATCHES WITH FLOWER BOX

STANDARD

ART.-NR. 803 ... SEITE 58
MODEL PAGE

BLUMENKASTEN-HALTER TYP F

FLOWER BOX BRACKET TYPE F

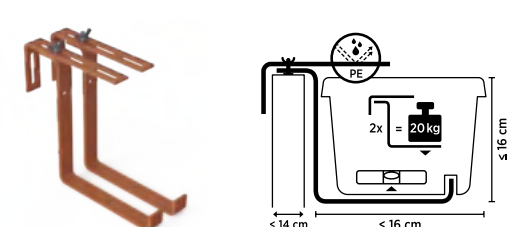

AUSFÜHRUNG: 1-FACH VERSTELLBAR
DESIGN: SIMPLE ADJUSTMENT

FARBE COLOUR	ART.-NR. MODEL	VE: MONTIERT PU: MOUNTED
06	39 815 000 06	10
38	39 815 000 38	10



PASSEND FÜR BLUMENKASTEN
MATCHES WITH FLOWER BOX

AQUA TOSCANA
ART.-NR. 825 ...
MODEL
SEITE 74
PAGE

TOSCANA
ART.-NR. 822 ...
MODEL
SEITE 60
PAGE

BLUMENKASTEN-HALTER TYP H

FLOWER BOX BRACKET TYPE H

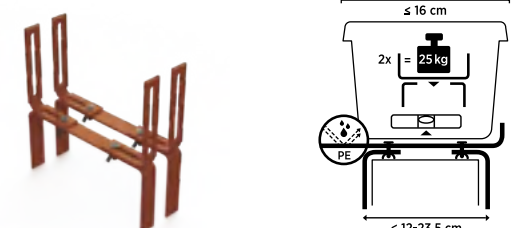

AUSFÜHRUNG: 1-FACH VERSTELLBAR
DESIGN: SIMPLE ADJUSTMENT

FARBE COLOUR	ART.-NR. MODEL	VE: MONTIERT PU: MOUNTED
06	39 812 000 06	10
08	39 812 000 08	10
10	39 812 000 10	10
11	39 812 000 11	10
38	39 812 000 38	10



PASSEND FÜR BLUMENKASTEN
MATCHES WITH FLOWER BOX

AQUA TOSCANA
ART.-NR. 825 ...
MODEL
SEITE 74
PAGE

TOSCANA
ART.-NR. 822 ...
MODEL
SEITE 60
PAGE

STANDARD
ART.-NR. 803 ...
MODEL
SEITE 58
PAGE



PASSEND FÜR BLUMENKASTEN
MATCHES WITH FLOWER BOX

STANDARD

ART.-NR. 803 ... SEITE 58
MODEL PAGE

Alle Maße in cm / all sizes in cm



STANDARD

UNTERSETZER
SAUCER

STANDARD UNTERSETZER
STANDARD SAUCER



terracotta /
terracotta (06)



ART.-NR. MODEL	ART.-NR. MODEL	ART.-NR. MODEL	ART.-NR. MODEL	ART.-NR. MODEL
808 006 06	808 006 07	808 006 10	-	-
808 008 06	808 008 07	808 008 10	808 008 38	-
808 010 06	808 010 07	808 010 10	808 010 38	-
808 012 06	808 012 07	808 012 10	808 012 38	808 012 70
808 014 06	808 014 07	808 014 10	808 014 38	808 014 70
808 016 06	808 016 07	808 016 10	808 016 38	808 016 70
808 018 06	808 018 07	808 018 10	808 018 38	-
808 021 06	808 021 07	808 021 10	808 021 38	808 021 70
808 024 06	808 024 07	808 024 10	808 024 38	-
808 027 06	808 027 07	808 027 10	808 027 38	808 027 70
808 030 06	808 030 07	808 030 10	808 030 38	-
808 034 06	808 034 07	808 034 10	808 034 38	808 034 70
808 040 06	808 040 07	808 040 10	808 040 38	-
808 045 06	808 045 07	808 045 10	-	-
808 050 06	808 050 07	808 050 10	-	-

braun /
brown (07)



ART.-NR. MODEL	ART.-NR. MODEL	ART.-NR. MODEL	ART.-NR. MODEL	ART.-NR. MODEL
808 006 06	808 006 07	808 006 10	-	-
808 008 06	808 008 07	808 008 10	808 008 38	-
808 010 06	808 010 07	808 010 10	808 010 38	-
808 012 06	808 012 07	808 012 10	808 012 38	808 012 70
808 014 06	808 014 07	808 014 10	808 014 38	808 014 70
808 016 06	808 016 07	808 016 10	808 016 38	808 016 70
808 018 06	808 018 07	808 018 10	808 018 38	-
808 021 06	808 021 07	808 021 10	808 021 38	808 021 70
808 024 06	808 024 07	808 024 10	808 024 38	-
808 027 06	808 027 07	808 027 10	808 027 38	808 027 70
808 030 06	808 030 07	808 030 10	808 030 38	-
808 034 06	808 034 07	808 034 10	808 034 38	808 034 70
808 040 06	808 040 07	808 040 10	808 040 38	-
808 045 06	808 045 07	808 045 10	-	-
808 050 06	808 050 07	808 050 10	-	-

weiß /
white (10)



ART.-NR. MODEL	ART.-NR. MODEL	ART.-NR. MODEL	ART.-NR. MODEL	ART.-NR. MODEL
808 006 06	808 006 07	808 006 10	-	-
808 008 06	808 008 07	808 008 10	808 008 38	-
808 010 06	808 010 07	808 010 10	808 010 38	-
808 012 06	808 012 07	808 012 10	808 012 38	808 012 70
808 014 06	808 014 07	808 014 10	808 014 38	808 014 70
808 016 06	808 016 07	808 016 10	808 016 38	808 016 70
808 018 06	808 018 07	808 018 10	808 018 38	-
808 021 06	808 021 07	808 021 10	808 021 38	808 021 70
808 024 06	808 024 07	808 024 10	808 024 38	-
808 027 06	808 027 07	808 027 10	808 027 38	808 027 70
808 030 06	808 030 07	808 030 10	808 030 38	-
808 034 06	808 034 07	808 034 10	808 034 38	808 034 70
808 040 06	808 040 07	808 040 10	808 040 38	-
808 045 06	808 045 07	808 045 10	-	-
808 050 06	808 050 07	808 050 10	-	-

anthrazit /
anthracite (38)



ART.-NR. MODEL	ART.-NR. MODEL	ART.-NR. MODEL	ART.-NR. MODEL	ART.-NR. MODEL
808 006 06	808 006 07	808 006 10	-	-
808 008 06	808 008 07	808 008 10	808 008 38	-
808 010 06	808 010 07	808 010 10	808 010 38	-
808 012 06	808 012 07	808 012 10	808 012 38	808 012 70
808 014 06	808 014 07	808 014 10	808 014 38	808 014 70
808 016 06	808 016 07	808 016 10	808 016 38	808 016 70
808 018 06	808 018 07	808 018 10	808 018 38	-
808 021 06	808 021 07	808 021 10	808 021 38	808 021 70
808 024 06	808 024 07	808 024 10	808 024 38	-
808 027 06	808 027 07	808 027 10	808 027 38	808 027 70
808 030 06	808 030 07	808 030 10	808 030 38	-
808 034 06	808 034 07	808 034 10	808 034 38	808 034 70
808 040 06	808 040 07	808 040 10	808 040 38	-
808 045 06	808 045 07	808 045 10	-	-
808 050 06	808 050 07	808 050 10	-	-

transparent klar /
transparent clear (70)



ART.-NR. MODEL	ART.-NR. MODEL	ART.-NR. MODEL	ART.-NR. MODEL	ART.-NR. MODEL
808 006 06	808 006 07	808 006 10	-	-
808 008 06	808 008 07	808 008 10	808 008 38	-
808 010 06	808 010 07	808 010 10	808 010 38	-
808 012 06	808 012 07	808 012 10	808 012 38	808 012 70
808 014 06	808 014 07	808 014 10	808 014 38	808 014 70
808 016 06	808 016 07	808 016 10	808 016 38	808 016 70
808 018 06	808 018 07	808 018 10	808 018 38	-
808 021 06	808 021 07	808 021 10	808 021 38	808 021 70
808 024 06	808 024 07	808 024 10	808 024 38	-
808 027 06	808 027 07	808 027 10	808 027 38	808 027 70
808 030 06	808 030 07	808 030 10	808 030 38	-
808 034 06	808 034 07	808 034 10	808 034 38	808 034 70
808 040 06	808 040 07	808 040 10	808 040 38	-
808 045 06	808 045 07	808 045 10	-	-
808 050 06	808 050 07	808 050 10	-	-



PASSEND ZU:
MATCHES WITH:



STANDARD BLUMENTOPF
STANDARD FLOWER POT

ART.-NR. 806 ... SEITE 98
MODEL PAGE

ART.-NR. BLUMENTOPF MODEL FLOWER POT	ART.-NR. UNTERSETZER MODEL SAUCER
806 006 ..	808 006 ..
806 008 ..	808 008 ..
806 010 ..	808 010 ..
806 012 ..	808 012 ..
806 014 ..	808 012 ..
806 016 ..	808 014 ..
806 018 ..	808 016 ..
806 020 ..	808 018 ..
806 022 ..	808 021 ..
806 024 ..	808 021 ..
806 026 ..	808 024 ..
806 028 ..	808 027 ..
806 032 ..	808 030 ..
806 036 ..	808 034 ..
806 040 ..	808 034 ..
806 045 ..	808 040 ..

GRÖSSE CA. Ø SIZE APPR.	VE PU	KARTON* CARTON*	EUROPALETTE** EURO PALLET **
6	40	-	-
8	40	-	-
10	40	1800	-
12	40	1120	-
14	40	1320	-
16	40	960	-
18	40	640	-
21	20	480	-
24	20	260	3000
27	20	220	2400
30	10	160	1360
34	10	240	1080
40	10	160	900
45	10	-	500
50	10	-	400



CYLINDRO

UNTERSETZER
SAUCER

CYLINDRO UNTERSETZER
CYLINDRO SAUCER



SEITE 232 / 240 / 231
PAGE

terracotta /
terracotta (06)

olivgrün /
olive (12)

anthrazit /
anthracite (38)

taupe /
taupe (40)



ART.-NR. MODEL	ART.-NR. MODEL	ART.-NR. MODEL	ART.-NR. MODEL	GRÖSSE CA. Ø SIZE APPR.	HÖHE CA. HEIGHT APPR.	VE PU
642 011 06	-	642 011 38	642 011 40	11	2,3	10
642 013 06	-	642 013 38	642 013 40	13	3,1	10
642 017 06	-	642 017 38	642 017 40	17	3,2	10
642 021 06	642 021 12	642 021 38	642 021 40	21	4,2	10
642 025 06	642 025 12	642 025 38	642 025 40	25	4,4	10
642 029 06	642 029 12	642 029 38	642 029 40	29	4,7	10
642 033 06	642 033 12	642 033 38	642 033 40	33	4,9	10
642 037 06	642 037 12	642 037 38	642 037 40	37	5,0	10
642 041 06	-	642 041 38	642 041 40	41	5,3	10
642 045 06	642 045 12	642 045 38	642 045 40	45	5,7	5
642 053 06	642 053 12	642 053 38	642 053 40	53	6,0	5

PASSEND ZU:
MATCHES WITH:

CYLINDRO BLUMENTOPF
CYLINDRO FLOWER POT



ART.-NR. 641 ... SEITE 102
MODEL PAGE

ART.-NR. BLUMENTOPF MODEL FLOWER POT	ART.-NR. UNTERSETZER MODEL SAUCER
-	642 011 ..
641 012 ..	642 013 ..
641 016 ..	642 017 ..
641 020 ..	642 021 ..
641 025 ..	642 025 ..
641 030 ..	642 029 ..
641 035 ..	642 033 ..
641 040 ..	642 037 ..
641 045 ..	642 041 ..
641 050 ..	642 045 ..
641 060 ..	642 053 ..

NEVADA BLUMENTOPF
NEVADA FLOWER POT



ART.-NR. 807 ... SEITE 100
MODEL PAGE

ART.-NR. BLUMENTOPF MODEL FLOWER POT	ART.-NR. UNTERSETZER MODEL SAUCER
807 010 ..	642 011 ..
807 012 ..	642 011 ..
807 013 ..	642 013 ..
807 015 ..	642 013 ..
807 017 ..	642 017 ..
807 020 ..	642 021 ..
807 024 ..	642 021 ..
807 027 ..	642 025 ..
807 032 ..	642 029 ..
807 035 ..	642 029 ..

AZTEKI BLUMENTOPF
AZTEKI FLOWER POT



ART.-NR. 695 ... SEITE 106
MODEL PAGE

ART.-NR. BLUMENTOPF MODEL FLOWER POT	ART.-NR. UNTERSETZER MODEL SAUCER
695 020 ..	642 017 ..
695 025 ..	642 021 ..
695 030 ..	642 025 ..
695 040 ..	642 033 ..
695 050 ..	642 037 ..

MONTANA

UNTERSETZER
SAUCER



MONTANA UNTERSETZER
MONTANA SAUCER



PASSEND ZU:
MATCHES WITH:

terracotta /
terracotta (06)



anthrazit /
anthracite (38)



ART.-NR. MODEL	ART.-NR. MODEL	GRÖSSE CA. Ø SIZE APPR.	HÖHE CA. HEIGHT APPR.	VE PU
655 016 06	655 016 38	16	2,7	20
655 020 06	655 020 38	20	3,5	20
655 022 06	655 022 38	22	3,7	20
655 026 06	655 026 38	26	4,0	20
655 032 06	655 032 38	32	4,9	10
655 038 06	655 038 38	38	5,0	10
655 042 06	655 042 38	42	5,0	10
655 050 06	655 050 38	50	5,3	10
655 058 06	655 058 38	58	5,4	5
655 064 06	655 064 38	64	9,5	1
655 078 06	655 078 38	78	11,5	1

**MONTANA
BLUMENTOPF**
MONTANA
FLOWER POT



ART.-NR. 640 ... SEITE 104
MODEL PAGE

ART.-NR. BLUMENTOPF MODEL FLOWER POT	ART.-NR. UNTERSETZER MODEL SAUCER
-	655 016 ..
640 020 ..	655 020 ..
640 025 ..	655 022 ..
640 030 ..	655 026 ..
640 035 ..	655 032 ..
640 040 ..	655 038 ..
640 045 ..	655 042 ..
640 050 ..	655 050 ..
640 060 ..	655 058 ..
640 070 ..	655 064 ..
640 080 ..	655 078 ..



NORA

UNTERSETZER
SAUCER

NORA UNTERSETZER
NORA SAUCER

terracotta /
terracotta (06)



anthrazit /
anthracite (38)



ART.-NR. MODEL	ART.-NR. MODEL	L x B CA. L x W APPR.	HÖHE CA. HEIGHT APPR.	VE PU
688 020 06	688 020 38	20 x 20	3,0	10
688 025 06	688 025 38	25 x 25	3,5	10
688 029 06	688 029 38	29 x 29	4,0	10
688 035 06	688 035 38	35 x 35	5,0	10
688 040 06	688 040 38	40 x 40	6,0	10
688 050 06	688 050 38	50 x 50	7,0	10



PASSEND ZU:
MATCHES WITH:

**NORA PFLANZ-
CONTAINER**
NORA PLANT
CONTAINER



ART.-NR. 687 ... SEITE 108
MODEL PAGE

ART.-NR. PFLANZCONTAINER MODEL PLANT CONTAINER	ART.-NR. UNTERSETZER MODEL SAUCER
687 023 ..	688 020 ..
687 028 ..	688 025 ..
687 033 ..	688 029 ..
687 040 ..	688 035 ..
687 048 ..	688 040 ..
687 058 ..	688 050 ..



MARCELLA

UNTERSETZER RUND
SAUCER ROUND

MARCELLA UNTERSETZER RUND MARCELLA SAUCER ROUND

impruneta /
impruneta (37)



ART.-NR.
MODEL

124 022 37

124 026 37

124 030 37

124 035 37

124 038 37

124 043 37

124 048 37

124 056 37

124 063 37

anthrazit /
anthracite (38)



ART.-NR.
MODEL

124 022 38

124 026 38

124 030 38

124 035 38

124 038 38

124 043 38

124 048 38

124 056 38

124 063 38

taupe /
taupe (40)



ART.-NR.
MODEL

-

124 026 40

124 030 40

124 035 40

124 038 40

124 043 40

124 048 40

124 056 40

124 063 40

betonfarbe /
concrete colour (59)



ART.-NR.
MODEL

-

124 030 59

-

124 038 59

124 043 59

124 048 59

-

-

AUSSEN- MASS CA. Ø OUTSIDE DIMENSION APPR.	HÖHE CA. HEIGHT APPR.	INNEN- MASS CA. Ø INSIDE DIMENSION APPR.	VE PU
22,0	4	16,5	1
26,0	4	20,0	1
30,0	4	23,0	1
35,0	4	28,0	1
37,5	4	31,5	1
42,5	4	35,5	1
47,0	4	40,0	1
55,0	4	48,0	1
63,0	5	56,0	1

PASSEND ZU:
MATCHES WITH:

MILANO PFLANZTOPF MILANO PLANTER

ART.-NR. 110 ... SEITE 174
MODEL PAGE



ART.-NR. PFLANZTOPF MODEL PLANTER	ART.-NR. UNTERSETZER MODEL SAUCER
110 030 ..	124 026 ..
110 035 ..	124 030 ..
110 040 ..	124 035 ..
110 045 ..	124 038 ..
110 055 ..	124 043 ..
110 060 ..	124 043 ..
110 070 ..	124 056 ..

PALERMO PFLANZTOPF PALERMO PLANTER

ART.-NR. 121 ... SEITE 172
MODEL PAGE



ART.-NR. PFLANZTOPF MODEL PLANTER	ART.-NR. UNTERSETZER MODEL SAUCER
121 030 ..	124 030 ..
121 035 ..	124 035 ..
121 040 ..	124 038 ..
121 045 ..	124 043 ..
121 050 ..	124 048 ..
121 060 ..	124 056 ..
121 070 ..	124 063 ..
121 080 ..	-
121 100 ..	-
121 120 ..	-

NAPOLI PFLANZTOPF NAPOLI PLANTER

ART.-NR. 130 ... SEITE 158
MODEL PAGE



ART.-NR. PFLANZTOPF MODEL PLANTER	ART.-NR. UNTERSETZER MODEL SAUCER
130 030 ..	124 030 ..
130 040 ..	124 038 ..
130 050 ..	124 043 ..
130 060 ..	124 048 ..

RIMINI PFLANZTOPF RIMINI PLANTER

ART.-NR. 143 ... SEITE 164
MODEL PAGE



ART.-NR. PFLANZTOPF MODEL PLANTER	ART.-NR. UNTERSETZER MODEL SAUCER
143 030 ..	124 026 ..
143 035 ..	124 030 ..
143 040 ..	124 035 ..
143 045 ..	124 038 ..
143 050 ..	124 048 ..
143 060 ..	124 048 ..



BIANCA

UNTERSETZER ECKIG
SAUCER SQUARE

BIANCA UNTERSETZER ECKIG BIANCA SAUCER SQUARE

impruneta / impruneta (37) anthrazit / anthracite (38) taupe / taupe (40) betonfarbe / concrete colour (59)

ART.-NR. MODEL	ART.-NR. MODEL	ART.-NR. MODEL	ART.-NR. MODEL	AUSSEN- MASS CA. OUTSIDE DIMENSION APPR.	HÖHE CA. HEIGHT APPR.	INNEN- MASS CA. INSIDE DIMENSION APPR.	VE PU
125 027 37	125 027 38	125 027 40	-	27,0 x 27,0	4	20,5 x 20,5	1
125 036 37	125 036 38	125 036 40	125 036 59	36,0 x 36,0	4	29,0 x 29,0	1
125 043 37	125 043 38	125 043 40	-	43,0 x 43,0	4	36,0 x 36,0	1
125 050 37	125 050 38	125 050 40	-	49,5 x 49,5	4	43,0 x 43,0	1



PASSEND ZU:
MATCHES WITH:

PARMA PFLANZGEFÄSS PARMA PLANTER



ART.-NR. 122 ... SEITE 176
MODEL PAGE

ART.-NR. PFLANZGEFÄSS ART.-NR. UNTERSETZER
MODEL PLANTER MODEL SAUCER

122 040 ..	125 036 ..
122 050 ..	125 043 ..

RAVENNA PFLANZTOPF RAVENNA PLANTER



ART.-NR. 146 ... SEITE 178
MODEL PAGE

ART.-NR. PFLANZTOPF ART.-NR. UNTERSETZER
MODEL PLANTER MODEL SAUCER

146 030 ..	125 027 ..
146 040 ..	125 036 ..
146 050 ..	125 043 ..



PLATO

UNTERSETZER
SAUCER

PLATO UNTERSETZER PLATO SAUCER



PASSEND ZU:
MATCHES WITH:

terracotta / terracotta (06)

anthrazit / anthracite (38)



ART.-NR. MODEL	ART.-NR. MODEL	L x B x H CA. L x W x H APPR.	VE PU
846 060 06	846 060 38	59 x 29 x 5,5	5
846 080 06	846 080 38	76 x 33 x 6,0	5
846 100 06	846 100 38	96 x 40 x 7,5	5

PLATO PFLANZTROG PLATO PLANT TROUGH



ART.-NR. 836 ... SEITE 114
MODEL PAGE

ART.-NR. PFLANZTROG ART.-NR. UNTERSETZER
MODEL PLANTER MODEL SAUCER

836 060 ..	846 060 ..
836 080 ..	846 080 ..
836 100 ..	846 100 ..





UNTERSETZER FÜR ORCHIDEENTOPF

SAUCER FOR ORCHID POT



ORCHIDEENSTÄBE

ORCHID RODS

UNTERSETZER FÜR ORCHIDEENTOPF

SAUCER FOR ORCHID POT

+ PASSEND ZU:
MATCHES WITH:

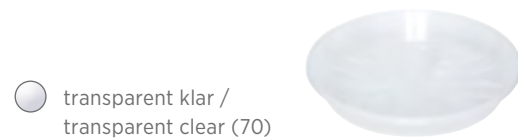

ORCHIDEENTOPF

ORCHID POT

ART.-NR. 340 ... SEITE 52
MODEL PAGE



ART.-NR. MODEL	GRÖSSE CA. Ø SIZE APPR.	VE PU
808 012 70	12	40
808 014 70	14	40
808 016 70	16	40
808 021 70	21	20

ART.-NR. PFLANZTOPF MODEL PLANTER	ART.-NR. UNTERSETZER MODEL SAUCER
340 012 70	808 012 70
340 015 70	808 014 70
340 017 70	808 016 70
340 019 70	808 021 70

ORCHIDEENSTÄBE IM DISPLAY

ORCHID RODS IN DISPLAY

verschiedene Farben /
different colours (99)



ART.-NR. MODEL	HÖHE CA. HEIGHT APPR.	VE PU
493 055 99	55	100



ERSATZTEIL
SPARE PART

ERSATZBRAUSEN FÜR GARTENGISSKANNE
REPLACEMENT ROSES GARDEN WATERING CAN



● schwarz / black (14)

ART.-NR. MODEL	PASSEND ZU KANNE 702 ... MATCHES CAN 702 ...	VE PU
712 001 14	1 Liter / 1 litres	20
712 003 14	2, 3 Liter / 2, 3 litres	20
712 005 14	5 Liter / 5 litres	20
712 014 14	10, 14 Liter / 10, 14 litres	20

+ PASSEND ZU: GARTENGISSKANNE
MATCHES WITH: GARDEN WATERING CAN
ART.-NR. 702 ... SEITE 22 - 25
MODEL PAGE

ERSATZBRAUSEN FÜR ANTIQUA GARTENGISSKANNE
REPLACEMENT ROSES ANTIQUA GARDEN WATERING CAN



● gold / gold-coloured (41)

ART.-NR. MODEL	VE PU
712 005 41	20
712 014 41	20

+ PASSEND ZU: ANTIQUA GARTENGISSKANNE
MATCHES WITH: ANTIQUA GARDEN WATERING CAN
ART.-NR. 701 ... SEITE 26
MODEL PAGE

WASSERSTANDSANZEIGER
WATER LEVEL INDICATOR

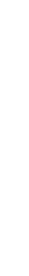

+ PASSEND ZU:
MATCHES WITH:

ALLEN BEWÄSSERUNGSBLUMENKÄSTEN
ALL SELF-WATERING FLOWER BOXES

ART.-NR. 801 ... MODEL	ART.-NR. 820 ... MODEL	ART.-NR. 825 ... MODEL	ART.-NR. 828 ... MODEL
ART.-NR. 829 ... MODEL	ART.-NR. 831 ... MODEL	ART.-NR. 837 ... MODEL	

ERSATZTEIL
SPARE PART

ERSATZTEIL
SPARE PART

ERSATZDECKEL FÜR E&K HOCHBEET
ADDITIONAL COVER FOR E&K RAISED BED



● transparent klar /
transparent clear (70)

ART.-NR. MODEL	LÄNGE x BREITE x HÖHE CA. LENGTH x WIDTH x HEIGHT APPR.	VE PU
283 080 70	80 x 40 x 22	1

+ PASSEND ZU: E&K HOCHBEET MIT DECKEL
MATCHES WITH: E&K RAISED BED WITH COVER
ART.-NR. 282 ... SEITE 92
MODEL PAGE

ERSATZTEIL
SPARE PART

AUFHÄNGER FÜR GALICIA
HANGER FOR GALICIA

terracotta / braun / weiß / anthrazit /
terracotta (06) brown (08) white (10) anthracite (38)



+ PASSEND ZU:
MATCHES WITH:

HÄNGEAMPEL GALICIA
HANGING BASKET GALICIA

ART.-NR. 643 025 .. **ART.-NR. 643 030 ..**
MODEL MODEL
SEITE 124 **SEITE 124**
PAGE PAGE

ART.-NR. MODEL	ART.-NR. MODEL	ART.-NR. MODEL	ART.-NR. MODEL	LÄNGE CA. LENGTH APPR.	PASSEND FÜR ART.-NR. MATCHES MODEL-NO.	VE PU
900 644 06	900 644 08	900 644 10	900 644 38	44,5	643 025 + ..	10
900 645 06	900 645 08	900 645 10	900 645 38	52,0	643 030 + ..	10

BEWÄSSERUNGSEINSATZ
WATERING SYSTEM

+ PASSEND ZU:
MATCHES WITH:

AQUA ANDALUCIA & AQUA GREEN & VIVA:

ART.-NR. 900 820 40 MODEL	FÜR KÄSTEN MIT LÄNGE 40 CM FOR BOXES WITH A LENGTH OF 40 CM
ART.-NR. 900 820 60 MODEL	FÜR KÄSTEN MIT LÄNGE 60 CM FOR BOXES WITH A LENGTH OF 60 CM
ART.-NR. 900 820 80 MODEL	FÜR KÄSTEN MIT LÄNGE 80 CM FOR BOXES WITH A LENGTH OF 80 CM
ART.-NR. 900 820 00 MODEL	FÜR KÄSTEN MIT LÄNGE 100 CM FOR BOXES WITH A LENGTH OF 100 CM



diverse Ausfertigungen / various versions

AQUA FLOR:

ART.-NR. 900 801 60 MODEL	FÜR KÄSTEN MIT LÄNGE 60 CM FOR BOXES WITH A LENGTH OF 60 CM
ART.-NR. 900 801 80 MODEL	FÜR KÄSTEN MIT LÄNGE 80 CM FOR BOXES WITH A LENGTH OF 80 CM
ART.-NR. 900 801 00 MODEL	FÜR KÄSTEN MIT LÄNGE 100 CM FOR BOXES WITH A LENGTH OF 100 CM

AQUA PALIDO:

ART.-NR. 900 830 50 MODEL	FÜR KÄSTEN MIT LÄNGE 50 CM FOR BOXES WITH A LENGTH OF 50 CM
ART.-NR. 900 830 75 MODEL	FÜR KÄSTEN MIT LÄNGE 75 CM FOR BOXES WITH A LENGTH OF 75 CM

AQUA TOSCANA:

ART.-NR. 900 825 60 MODEL	FÜR KÄSTEN MIT LÄNGE 60 CM FOR BOXES WITH A LENGTH OF 60 CM
ART.-NR. 900 825 80 MODEL	FÜR KÄSTEN MIT LÄNGE 80 CM FOR BOXES WITH A LENGTH OF 80 CM
ART.-NR. 900 825 00 MODEL	FÜR KÄSTEN MIT LÄNGE 100 CM FOR BOXES WITH A LENGTH OF 100 CM

NEO-LINE:

ART.-NR. 900 829 50 MODEL	FÜR KÄSTEN MIT LÄNGE 50 CM FOR BOXES WITH A LENGTH OF 50 CM
ART.-NR. 900 829 75 MODEL	FÜR KÄSTEN MIT LÄNGE 75 CM FOR BOXES WITH A LENGTH OF 75 CM

ERSATZTEIL
SPARE PART

ERSATZTEIL
SPARE PART

AUSLAUFHAHN FÜR KANISTER
POURER FOR CANISTER



ART.-NR. MODEL	VE PU
900 205 03	1

+ PASSEND ZU: KANISTER / KANISTER MIT HAHN
MATCHES WITH: CANISTER

ART.-NR. 202 ... **ART.-NR. 205 ...**
MODEL MODEL
SEITE 188
PAGE

VERSTÄRKUNGSTREBE
REINFORCEMENT STRUT

+ PASSEND ZU:
MATCHES WITH:

AQUA ANDALUCIA & AQUA GREEN:

ART.-NR. 900 837 99
MODEL

AQUA FLOR:
ART.-NR. 900 801 99
MODEL

AQUA TOSCANA & TOSCANA:
ART.-NR. 900 825 99
MODEL

STANDARD:
ART.-NR. 900 803 99
MODEL

NEO-LINE:
ART.-NR. 900 829 99
MODEL



ERSATZTEIL
SPARE PART





POS

Übersicht / Overview

Displayboxen _____ 216

Display boxes

Displayständer _____ 238

Display stands

Displayboxen

Display boxes

GARTENGISSKANNE, 5 LITER — DISPLAYBOX

GARDEN WATERING CAN, 5 LITRES — DISPLAY BOX

ART.-NR. 4702 005 01

MODEL

ART.-NR. EINZELPRODUKT MODEL INDIVIDUAL PRODUCT	INHALT CA. VOLUME APPR.	MENGE/STÜCK QUANTITY/PIECE
702 005 01	5	130
gesamt/total		130

EINZELPRODUKT: GARTENGISSKANNE — 22
INDIVIDUAL PRODUCT: GARDEN WATERING CAN

FARBlich SORTIERT (FARBCODE)

ASSORTED COLOURS
(COLOUR CODE)

● 01 — grün / green

Hinweis: Farbigeit der Verpackungskartons (Displayboxen) kann abweichen. / Please note: The colour of the display boxes may vary.

GARTENGISSKANNE, 5 UND 10 LITER — DISPLAYBOX

GARDEN WATERING CAN, 5 AND 10 LITRES — DISPLAY BOX

ART.-NR. 550 000 01

MODEL

ART.-NR. EINZELPRODUKT MODEL INDIVIDUAL PRODUCT	INHALT CA. VOLUME APPR.	MENGE/STÜCK QUANTITY/PIECE
702 005 01	5	35
702 010 01	10	50
gesamt/total		85

EINZELPRODUKT: GARTENGISSKANNE — 22
INDIVIDUAL PRODUCT: GARDEN WATERING CAN

FARBlich SORTIERT (FARBCODE)

ASSORTED COLOURS
(COLOUR CODE)

● 01 — grün / green

Hinweis: Farbigeit der Verpackungskartons (Displayboxen) kann abweichen. / Please note: The colour of the display boxes may vary.

Beispielbild /
Example image



**EUROPALETTE
120 x 80 CM**
EURO PALLET
120 x 80 CM

GARTENGISSKANNE, 10 LITER — DISPLAYBOX

GARDEN WATERING CAN, 10 LITRES — DISPLAY BOX

ART.-NR. 4702 010 01

MODEL

ART.-NR. EINZELPRODUKT MODEL INDIVIDUAL PRODUCT	INHALT CA. VOLUME APPR.	MENGE/STÜCK QUANTITY/PIECE
702 010 01	10	65
gesamt/total		65

EINZELPRODUKT: GARTENGISSKANNE — 22
INDIVIDUAL PRODUCT: GARDEN WATERING CAN

FARBlich SORTIERT (FARBCODE)

ASSORTED COLOURS
(COLOUR CODE)

● 01 — grün / green

Hinweis: Farbigeit der Verpackungskartons (Displayboxen) kann abweichen. / Please note: The colour of the display boxes may vary.

BLUMENGISSKANNE — DISPLAYBOX

FLOWER WATERING CAN — DISPLAY BOX

ART.-NR. 572 001 98

MODEL

ART.-NR. EINZELPRODUKT MODEL INDIVIDUAL PRODUCT	INHALT CA. VOLUME APPR.	MENGE/STÜCK QUANTITY/PIECE
702 001 31		60
702 001 43	1	60
702 001 38		50
702 001 33		50
gesamt/total		220

EINZELPRODUKT: BLUMENGISSKANNE — 24
INDIVIDUAL PRODUCT: FLOWER WATERING CAN

BLUMENGISSKANNE — DISPLAYBOX

FLOWER WATERING CAN — DISPLAY BOX

ART.-NR. 572 002 96

MODEL

ART.-NR. EINZELPRODUKT MODEL INDIVIDUAL PRODUCT	INHALT CA. VOLUME APPR.	MENGE/STÜCK QUANTITY/PIECE
702 002 31		30
702 002 43	2	30
702 002 38		30
702 002 33		20
gesamt/total		110

EINZELPRODUKT: BLUMENGISSKANNE — 24
INDIVIDUAL PRODUCT: FLOWER WATERING CAN



FARBlich SORTIERT (FARBCODE)

ASSORTED COLOURS
(COLOUR CODE)

- 31 — mintgrün / mint green
- 43 — pink / pink
- 38 — anthrazit / anthracite
- 33 — hellblau / light blue

**HALBPALETTE
80 x 60 CM**
HALF PALLET
80 x 60 CM



FARBlich SORTIERT (FARBCODE)

ASSORTED COLOURS
(COLOUR CODE)

- 31 — mintgrün / mint green
- 43 — pink / pink
- 38 — anthrazit / anthracite
- 33 — hellblau / light blue

**HALBPALETTE
80 x 60 CM**
HALF PALLET
80 x 60 CM



LIV ÜBERTOPF – DISPLAYBOX

LIV CACHEPOT – DISPLAY BOX



ART.-NR. 545 000 97

MODEL

ART.-NR. EINZELPRODUKT MODEL INDIVIDUAL PRODUCT	GRÖSSE CA. Ø SIZE APPR.	MENGE/STÜCK QUANTITY/PIECE
450 016 38	Übertopf, 16 cm Cachepot	20
450 016 10	Übertopf, 16 cm Cachepot	10
450 016 19	Übertopf, 16 cm Cachepot	10
450 016 20	Übertopf, 16 cm Cachepot	5
450 019 38	Übertopf, 19 cm Cachepot	20
450 019 10	Übertopf, 19 cm Cachepot	10
450 019 19	Übertopf, 19 cm Cachepot	10
450 019 20	Übertopf, 19 cm Cachepot	5
450 023 38	Übertopf, 23 cm Cachepot	20
450 023 10	Übertopf, 23 cm Cachepot	10
450 023 19	Übertopf, 23 cm Cachepot	10
450 023 20	Übertopf, 23 cm Cachepot	5
450 030 38	Übertopf, 30 cm Cachepot	20
450 030 10	Übertopf, 30 cm Cachepot	10
450 030 19	Übertopf, 30 cm Cachepot	10
450 030 20	Übertopf, 30 cm Cachepot	5
450 040 38	Übertopf, 40 cm Cachepot	20
450 040 10	Übertopf, 40 cm Cachepot	10
450 040 19	Übertopf, 40 cm Cachepot	10
450 040 20	Übertopf, 40 cm Cachepot	5
gesamt/total		225

FARBLICH SORTIERT (FARBCODE)
ASSORTED COLOURS (COLOUR CODE)

- 38 – anthrazit / anthracite
- 10 – weiß / white
- 19 – beerenrot / berry
- 20 – pistazie / pistachio



EUROPALETTE
120 x 80 CM
EURO PALLET
120 x 80 CM



LIV
ÜBERTOPF
CACHEPOT

PURE ÜBERTOPF – DISPLAYBOX

PURE CACHEPOT – DISPLAY BOX

ART.-NR 548 035 38

MODEL

ART.-NR. EINZELPRODUKT MODEL INDIVIDUAL PRODUCT	GRÖSSE CA. Ø SIZE APPR.	MENGE/STÜCK QUANTITY/PIECE
481 011 35	11	50
481 011 38		50
481 013 35	13	50
481 013 38		50
481 015 35	15	50
481 015 38		50
481 018 35	18	40
481 018 38		40
481 021 35	21	30
481 021 38		30
481 025 35	25	30
481 025 38		30
gesamt/total		500

EINZELPRODUKT: PURE ÜBERTOPF – 50
INDIVIDUAL PRODUCT: PURE CACHEPOT

Alle Maße in cm / all sizes in cm



FARBLICH SORTIERT (FARBCODE)
ASSORTED COLOURS (COLOUR CODE)

- 35 – creme / creme
- 38 – anthrazit / anthracite

HALBPALETTE
80 x 60 CM
HALF PALLET
80 x 60 CM



STANDARD BLUMENKASTEN — DISPLAYBOX

STANDARD FLOWER BOX — DISPLAY BOX



ART.-NR. 530 003 + .. (FARBCODE)
MODEL + COLOUR CODE

LÄNGE CA. LENGTH APPR.	MENGE/STÜCK QUANTITY/PIECE
60	130
80	150
100	120
gesamt/total	400

EINZELPRODUKT: STANDARD BLUMENKASTEN — 58
INDIVIDUAL PRODUCT: STANDARD FLOWER BOX

FARBCODE
COLOUR CODE

- 06 — terracotta / terracotta
- 08 — braun / brown
- 10 — weiß / white
- 11 — dunkelgrün / dark green
- 20 — pistazie / pistachio
- 38 — anthrazit / anthracite



Abb. / Fig.
530 003 06

EUROPALETTE
120 x 80 CM
EURO PALLET
120 x 80 CM



VIVA
BEWÄSSERUNGSBLUMENKASTEN
SELF-WATERING FLOWER BOX

STANDARD BLUMENKASTEN — DISPLAYBOX

STANDARD FLOWER BOX — DISPLAY BOX



ART.-NR 540 004 + .. (FARBCODE)
MODEL + COLOUR CODE

LÄNGE CA. LENGTH APPR.	MENGE/STÜCK QUANTITY/PIECE
40	50
60	120
80	140
100	120
gesamt/total	430

EINZELPRODUKT: STANDARD BLUMENKASTEN — 58
INDIVIDUAL PRODUCT: STANDARD FLOWER BOX

FARBCODE
COLOUR CODE

- 06 — terracotta / terracotta
- 08 — braun / brown
- 10 — weiß / white
- 11 — dunkelgrün / dark green
- 38 — anthrazit / anthracite



Abb. / Fig.
540 004 38

EUROPALETTE
120 x 80 CM
EURO PALLET
120 x 80 CM

VIVA BEWÄSSERUNGSBLUMENKASTEN — DISPLAYBOX GEMISCHT

VIVA SELF-WATERING FLOWER BOX — DISPLAY BOX ASSORTED

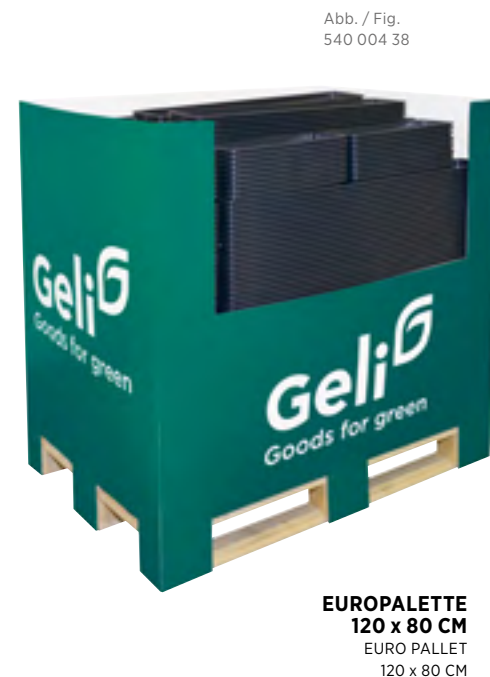

ART.-NR. 520 038 06
MODEL

ART.-NR. EINZELPRODUKT MODEL INDIVIDUAL PRODUCT	LÄNGE CA. LENGTH APPR.	MENGE/STÜCK QUANTITY/PIECE
820 040 06	40	3
820 060 06	60	10
820 080 06	80	12
820 100 06	100	7
820 040 38	40	7
820 060 38	60	17
820 080 38	80	22
820 100 38	100	10
gesamt/total		88

EINZELPRODUKT: VIVA BEWÄSSERUNGSBLUMENKASTEN — 66
INDIVIDUAL PRODUCT: VIVA SELF-WATERING FLOWER BOX



FARBlich SORTIERT
(FARBCODE)
ASSORTED COLOURS
(COLOUR CODE)

- 06 — terracotta / terracotta
- 38 — anthrazit / anthracite

EUROPALETTE
120 x 80 CM
EURO PALLET
120 x 80 CM

WEITERE VIVA-DISPLAYBOXEN AUF DER NÄCHSTEN SEITE /
MORE VIVA DISPLAY BOXES ON THE NEXT PAGE



VIVA BEWÄSSERUNGSBLUMENKASTEN – DISPLAYBOX EINFARBIG

VIVA SELF-WATERING FLOWER BOX – DISPLAY BOX ONE COLOUR



ART.-NR. 520 000 + .. (FARBCODE)

MODEL + COLOUR CODE

ART.-NR. EINZELPRODUKT MODEL INDIVIDUAL PRODUCT	LÄNGE CA. LENGTH APPR.	MENGE/STÜCK QUANTITY/PIECE
820 040 + ..	40	10
820 060 + ..	60	27
820 080 + ..	80	34
820 100 + ..	100	17
gesamt/total		88

FARBCODE

COLOUR CODE

- 06 – terracotta / terracotta
- 10 – weiß / white
- 38 – anthrazit / anthracite
- 59 – betonfarbe / concrete colour

Hinweis: Farbigkeit der Verpackungskartons (Displayboxen) kann abweichen. / Please note: The colour of the display boxes may vary.

EINZELPRODUKT: VIVA BEWÄSSERUNGSBLUMENKASTEN – 66
INDIVIDUAL PRODUCT: VIVA SELF-WATERING FLOWER BOX

VIVA BEWÄSSERUNGSBLUMENKASTEN INKL. PFLANZGESTELL – DISPLAYBOX

VIVA SELF-WATERING FLOWER BOX INCL. PLANT STAND – DISPLAY BOX



ART.-NR. 520 060 99

MODEL

ART.-NR. EINZELPRODUKT MODEL INDIVIDUAL PRODUCT	LÄNGE CA. LENGTH APPR.	MENGE/STÜCK QUANTITY/PIECE
820 060 06	Blumenkasten, 60 cm Flower box	24
820 060 10	Blumenkasten, 60 cm Flower box	10
820 060 38	Blumenkasten, 60 cm Flower box	24
820 060 59	Blumenkasten, 60 cm Flower box	10
100 820 60	Pflanzgestell, 60 cm Plant stand	10
gesamt/total		78

FARBlich SORTIERT (FARBCODE)

ASSORTED COLOURS (COLOUR CODE)

- 06 – terracotta / terracotta
- 10 – weiß / white
- 38 – anthrazit / anthracite
- 59 – betonfarbe / concrete colour

Hinweis: Farbigkeit der Verpackungskartons (Displayboxen) kann abweichen. / Please note: The colour of the display boxes may vary.

EINZELPRODUKT: VIVA BEWÄSSERUNGSBLUMENKASTEN – 66
INDIVIDUAL PRODUCT: VIVA SELF-WATERING FLOWER BOX

EINZELPRODUKT: VIVA PFLANZGESTELL – 66
INDIVIDUAL PRODUCT: VIVA PLANT STAND



AQUA PALIDO BEWÄSSERUNGSBLUMENKASTEN – DISPLAYBOX

AQUA PALIDO SELF-WATERING FLOWER BOX – DISPLAY BOX



ART.-NR. 583 999 95

MODEL

ART.-NR. EINZELPRODUKT MODEL INDIVIDUAL PRODUCT	LÄNGE CA. LENGTH APPR.	MENGE/STÜCK QUANTITY/PIECE
831 050 10		10
831 050 38	50	10
831 050 86		4
<hr/>		
831 075 10		7
831 075 38	75	7
831 075 86		4
gesamt/total		42

EINZELPRODUKT: AQUA PALIDO BEWÄSSERUNGSBLUMENKASTEN – 70
INDIVIDUAL PRODUCT: AQUA PALIDO SELF-WATERING FLOWER BOX

FARBlich SORTIERT (FARBCODE)

ASSORTED COLOURS (COLOUR CODE)

- 10 – weiß / white
- 38 – anthrazit / anthracite
- 86 – zartrosa / soft pink

Hinweis: Farbigkeit der Verpackungskartons (Displayboxen) kann abweichen. / Please note: The colour of the display boxes may vary.



EUROPALETTE
120 x 80 CM
EURO PALLET
120 x 80 CM

AQUA GREEN BEWÄSSERUNGSBLUMENKASTEN – DISPLAYBOX

AQUA GREEN SELF-WATERING FLOWER BOX – DISPLAY BOX



ART.-NR. 537 000 + .. (FARBCODE)

MODEL + COLOUR CODE

LÄNGE CA. LENGTH APPR.	MENGE/STÜCK QUANTITY/PIECE	
60	15	
80	35	
100	30	
gesamt/total		80

FARBCODE

COLOUR CODE

- 06 – terracotta / terracotta
- 08 – braun / brown
- 10 – weiß / white
- 11 – dunkelgrün / dark green
- 38 – anthrazit / anthracite

EINZELPRODUKT: AQUA GREEN BEWÄSSERUNGSBLUMENKASTEN – 72
INDIVIDUAL PRODUCT: AQUA GREEN SELF-WATERING FLOWER BOX

Abb./ Fig.
537 000 06



EUROPALETTE
120 x 80 CM
EURO PALLET
120 x 80 CM

AQUA FLOR BEWÄSSERUNGSBLUMENKASTEN – DISPLAYBOX

AQUA FLOR SELF-WATERING FLOWER BOX – DISPLAY BOX

Abb. / Fig.
581 000 10



ART.-NR. 581 000 + .. (FARBCODE)

MODEL + COLOUR CODE

LÄNGE CA. LENGTH APPR.	MENGE/STÜCK QUANTITY/PIECE
60	15
80	30
100	15
gesamt/total	60

FARBCODE
COLOUR CODE

- 06 – terracotta / terracotta
- 08 – braun / brown
- 10 – weiß / white
- 38 – anthrazit / anthracite



EUROPALETTE
120 x 80 CM
EURO PALLET
120 x 80 CM

EINZELPRODUKT: AQUA FLOR BEWÄSSERUNGSBLUMENKASTEN – 80
INDIVIDUAL PRODUCT: AQUA FLOR SELF-WATERING FLOWER BOX



AQUA FLOR
BEWÄSSERUNGSBLUMENKASTEN
SELF-WATERING FLOWER BOX

AQUA TOSCANA BEWÄSSERUNGSBLUMENKASTEN

OHNE UNTERSETZER – DISPLAYBOX

AQUA TOSCANA SELF-WATERING FLOWER BOX
WITHOUT SAUCER – DISPLAY BOX

Abb. / Fig.
525 000 06



ART.-NR. 525 000 + .. (FARBCODE)

MODEL + COLOUR CODE

LÄNGE CA. LENGTH APPR.	MENGE/STÜCK QUANTITY/PIECE
60	30
80	30
100	30
gesamt/total	90

FARBCODE
COLOUR CODE

- 06 – terracotta / terracotta
- 38 – anthrazit / anthracite



EUROPALETTE
120 x 80 CM
EURO PALLET
120 x 80 CM

EINZELPRODUKT: AQUA TOSCANA BEWÄSSERUNGSBLUMENKASTEN – 74
INDIVIDUAL PRODUCT: AQUA TOSCANA SELF-WATERING FLOWER BOX

AQUA ANDALUCIA BEWÄSSERUNGSBLUMENKASTEN – DISPLAYBOX

AQUA ANDALUCIA SELF-WATERING FLOWER BOX – DISPLAY BOX

Abb. / Fig.
528 000 38



ART.-NR. 528 000 + .. (FARBCODE)

MODEL + COLOUR CODE

LÄNGE CA. LENGTH APPR.	MENGE/STÜCK QUANTITY/PIECE
60	15
80	30
100	15
gesamt/total	60

FARBCODE
COLOUR CODE

- 06 – terracotta / terracotta
- 08 – braun / brown
- 10 – weiß / white
- 38 – anthrazit / anthracite



EUROPALETTE
120 x 80 CM
EURO PALLET
120 x 80 CM

EINZELPRODUKT: AQUA ANDALUCIA BEWÄSSERUNGSBLUMENKASTEN – 76
INDIVIDUAL PRODUCT: AQUA ANDALUCIA SELF-WATERING FLOWER BOX

EASY PFLANZGEFÄSS FÜR EUROPALETTEN – DISPLAYBOX

EASY PLANTER FOR EURO PALLETS – DISPLAY BOX



ART.-NR. 582 037 98

MODEL

ART.-NR. EINZELPRODUKT MODEL INDIVIDUAL PRODUCT	LÄNGE CA. LENGTH APPR.	MENGE/STÜCK QUANTITY/PIECE
802 037 38	37	60
802 037 59		30
802 037 86		15
802 037 87		15
gesamt/total		120

EINZELPRODUKT: EASY PFLANZGEFÄSS FÜR EUROPALETTEN – 86
INDIVIDUAL PRODUCT: EASY PLANTER FOR EURO PALLETS

FARBLICH SORTIERT (FARBCODE) ASSORTED COLOURS (COLOUR CODE)

- 38 – anthrazit / anthracite
- 59 – betonfarbe / concrete colour
- 86 – zartrosa / soft pink
- 87 – zartblau / soft blue



**VIERTELPALETTE
40 x 60 CM**
QUARTER PALLET
40 x 60 CM

EASY PFLANZGEFÄSS FÜR EUROPALETTEN – DISPLAYBOX

EASY PLANTER FOR EURO PALLETS – DISPLAY BOX



ART.-NR. 582 037 99

MODEL

ART.-NR. EINZELPRODUKT MODEL INDIVIDUAL PRODUCT	LÄNGE CA. LENGTH APPR.	MENGE/STÜCK QUANTITY/PIECE
802 037 38	37	90
802 037 59		30
gesamt/total		120

EINZELPRODUKT: EASY PFLANZGEFÄSS FÜR EUROPALETTEN – 86
INDIVIDUAL PRODUCT: EASY PLANTER FOR EURO PALLETS

FARBLICH SORTIERT (FARBCODE) ASSORTED COLOURS (COLOUR CODE)

- 38 – anthrazit / anthracite
- 59 – betonfarbe / concrete colour

Hinweis: Farbigkeit der Verpackungskartons (Displayboxen) kann abweichen. / Please note: The colour of the display boxes may vary.

EASY PFLANZGEFÄSS FÜR EUROPALETTEN – DISPLAYBOX

EASY PLANTER FOR EURO PALLETS – DISPLAY BOX



ART.-NR. 582 000 + .. (FARBCODE)

MODEL + COLOUR CODE

ART.-NR. EINZELPRODUKT MODEL INDIVIDUAL PRODUCT	LÄNGE CA. LENGTH APPR.	MENGE/STÜCK QUANTITY/PIECE
802 010 + ..	10	120
802 037 + ..	37	90
gesamt/total		210

EINZELPRODUKT: EASY PFLANZGEFÄSS FÜR EUROPALETTEN – 86
INDIVIDUAL PRODUCT: EASY PLANTER FOR EURO PALLETS

FARBCODE COLOUR CODE

- 38 – anthrazit / anthracite
- 59 – betonfarbe / concrete colour

Hinweis: Farbigkeit der Verpackungskartons (Displayboxen) kann abweichen. / Please note: The colour of the display boxes may vary.

EASY PFLANZGEFÄSS FÜR EUROPALETTEN – DISPLAYBOX

EASY PLANTER FOR EURO PALLETS – DISPLAY BOX



ART.-NR. 582 000 99

MODEL

ART.-NR. EINZELPRODUKT MODEL INDIVIDUAL PRODUCT	LÄNGE CA. LENGTH APPR.	MENGE/STÜCK QUANTITY/PIECE
802 010 38	10	80
802 010 59		40
802 037 38	37	60
802 037 59		30
gesamt/total		210

EINZELPRODUKT: EASY PFLANZGEFÄSS FÜR EUROPALETTEN – 86
INDIVIDUAL PRODUCT: EASY PLANTER FOR EURO PALLETS

FARBLICH SORTIERT (FARBCODE) ASSORTED COLOURS (COLOUR CODE)

- 38 – anthrazit / anthracite
- 59 – betonfarbe / concrete colour



**VIERTELPALETTE
40 x 60 CM**
QUARTER PALLET
40 x 60 CM

EASY PFLANZGEFÄSS FÜR EUROPALETTEN – DISPLAYBOX

EASY PLANTER FOR EURO PALLETS – DISPLAY BOX



ART.-NR. 582 037 38

MODEL

ART.-NR. EINZELPRODUKT MODEL INDIVIDUAL PRODUCT	LÄNGE CA. LENGTH APPR.	MENGE/STÜCK QUANTITY/PIECE
802 037 38	37	120
gesamt/total		120

EINZELPRODUKT: EASY PFLANZGEFÄSS FÜR EUROPALETTEN – 86
INDIVIDUAL PRODUCT: EASY PLANTER FOR EURO PALLETS

FARBLICH SORTIERT (FARBCODE) ASSORTED COLOURS (COLOUR CODE)

- 38 – anthrazit / anthracite

Hinweis: Farbigkeit der Verpackungskartons (Displayboxen) kann abweichen. / Please note: The colour of the display boxes may vary.



CONNY WAND- UND GELÄNDERTOPF – DISPLAYBOX

CONNY WALL AND RAILING PLANTER – DISPLAY BOX



ART.-NR. 532 016 99

MODEL

ART.-NR. EINZELPRODUKT MODEL INDIVIDUAL PRODUCT	GRÖSSE CA. Ø SIZE APPR.	MENGE/STÜCK QUANTITY/PIECE
320 016 38	16	60
320 016 59		22
320 016 86		10
320 016 87		10
gesamt/total		102

EINZELPRODUKT: CONNY WAND- UND GELÄNDERTOPF – 88
INDIVIDUAL PRODUCT: CONNY WALL AND RAILING PLANTER



FARBlich SORTIERT (FARBCODE)
ASSORTED COLOURS (COLOUR CODE)

- 38 – anthrazit / anthracite
- 59 – betonfarbe / concrete colour
- 86 – zartrosa / soft pink
- 87 – zartblau / soft blue

VIERTELPALETTE
40 x 60 CM
QUARTER PALLET
40 x 60 CM



OLIVERA
JARDINIERE
PLANTER

OLIVERA JARDINIERE IM DISPLAY

OLIVERA PLANTER IN DISPLAY

ART.-NR. 890 025 96

MODEL

BEZEICHNUNG DESCRIPTION	MENGE/STÜCK QUANTITY/PIECE
Blumenkasten weiß, 25 cm Flower box white, 25 cm	12
Blumenkasten anthrazit, 25 cm Flower box anthracite, 25 cm	24
Blumenkasten betonfarbe, 25 cm Flower box concrete colour, 25 cm	12
Blumenkasten eukalyptus, 25 cm Flower box eucalyptus, 25 cm	12
Blumenkasten zartrosa, 25 cm Flower box soft pink, 25 cm	12
gesamt/total	72

EINZELPRODUKT: OLIVERA JARDINIERE – 90
INDIVIDUAL PRODUCT: OLIVERA PLANTER



DISPLAYBOX L x B x H:
62 x 27 x 30 CM
DISPLAY BOX L x W x H:
62 x 27 x 30 CM

FARBlich SORTIERT (FARBCODE)
ASSORTED COLOURS (COLOUR CODE)

- 10 – weiß / white
- 38 – anthrazit / anthracite
- 59 – betonfarbe / concrete colour
- 68 – eukalyptus / eucalyptus
- 86 – zartrosa / soft pink



Conny - Clever Verpackt:

Die Verpackung ist so konzipiert, dass der Conny optimal und überall platzsparend gestapelt werden kann.

CONNY - CLEVER PACKAGING:

The packaging is designed to be stacked space-savily everywhere.



LIEFERUMFANG:
TOPF, HALTERUNG, GURT (GRAU)
INCLUDED IN DELIVERY:
PLANTER, MOUNT BRACKET, STRAP (GREY)



STANDARD BLUMENTÖPFE & UNTERSETZER — DISPLAYBOX

STANDARD FLOWER POTS & SAUCERS — DISPLAY BOX



ART.-NR. 563 000 + .. (FARBCODE)

MODEL + COLOUR CODE

ART.-NR. + FARBCODE MODEL + COLOUR CODE	BEZEICHNUNG, GRÖSSE CA. Ø DESCRIPTION, SIZE APPR.	MENGE/STÜCK QUANTITY/PIECE
806 012 + ..	Blumentopf, 12 cm Flower pot	80
806 014 + ..	Blumentopf, 14 cm Flower pot	80
806 016 + ..	Blumentopf, 16 cm Flower pot	80
806 018 + ..	Blumentopf, 18 cm Flower pot	80
806 020 + ..	Blumentopf, 20 cm Flower pot	70
806 022 + ..	Blumentopf, 22 cm Flower pot	70
806 024 + ..	Blumentopf, 24 cm Flower pot	70
806 026 + ..	Blumentopf, 26 cm Flower pot	70
808 010 + ..	Untersetzer, 10 cm Saucer	80
808 012 + ..	Untersetzer, 12 cm Saucer	120
808 014 + ..	Untersetzer, 14 cm Saucer	120
808 016 + ..	Untersetzer, 16 cm Saucer	80
808 018 + ..	Untersetzer, 18 cm Saucer	80
808 021 + ..	Untersetzer, 21 cm Saucer	80
808 024 + ..	Untersetzer, 24 cm Saucer	80
gesamt/total		1.240

FARBCODE
COLOUR CODE

- 06 — terracotta / terracotta
- 07 — braun / brown
- 10 — weiß / white



Abb. / Fig. 563 000 06

HALBPALETTE
80 x 60 CM
HALF PALLET
80 x 60 CM

EINZELPRODUKT: STANDARD BLUMENTOPF — 98
INDIVIDUAL PRODUCT: STANDARD FLOWER POT

EINZELPRODUKT: STANDARD UNTERSETZER — 200
INDIVIDUAL PRODUCT: STANDARD SAUCER

NEVADA BLUMENTOPF & CYLINDRO UNTERSETZER — DISPLAYBOX

NEVADA FLOWER POT & CYLINDRO SAUCER — DISPLAY BOX

ART.-NR. 507 000 99

MODEL

ART.-NR. EINZELPRODUKT MODEL INDIVIDUAL PRODUCT	BEZEICHNUNG, GRÖSSE CA. Ø DESCRIPTION, SIZE APPR.	MENGE/STÜCK QUANTITY/PIECE
807 024 06	Blumentopf Nevada, 24 cm	60
807 024 38	Flower pot	60
807 035 06	Blumentopf Nevada, 35 cm	50
807 035 38	Flower pot	50
642 021 06	Untersetzer Cylindro, 21 cm	50
642 021 38	Saucer	50
642 029 06	Untersetzer Cylindro, 29 cm	40
642 029 38	Saucer	40
gesamt/total		400

EINZELPRODUKT: NEVADA BLUMENTOPF — 100
INDIVIDUAL PRODUCT: NEVADA FLOWER POT

EINZELPRODUKT: CYLINDRO UNTERSETZER — 202
INDIVIDUAL PRODUCT: CYLINDRO SAUCER



FARBBLICH SORTIERT (FARBCODE)
ASSORTED COLOURS (COLOUR CODE)

HALBPALETTE
80 x 60 CM
HALF PALLET
80 x 60 CM

- 06 — terracotta / terracotta
- 38 — anthrazit / anthracite

GALICIA HÄNGEAMPEL — DISPLAYBOX

GALICIA HANGING BASKET — DISPLAY BOX

ART.-NR. 543 000 99

MODEL

ART.-NR. EINZELPRODUKT MODEL INDIVIDUAL PRODUCT	GRÖSSE CA. Ø SIZE APPR.	MENGE/STÜCK QUANTITY/PIECE
643 025 06		25
643 025 08	25	25
643 025 38		25
643 030 06		20
643 030 08	30	20
643 030 38		20
gesamt/total		135

EINZELPRODUKT: GALICIA HÄNGEAMPEL — 124
INDIVIDUAL PRODUCT: GALICIA HANGING BASKET



FARBBLICH SORTIERT (FARBCODE)
ASSORTED COLOURS (COLOUR CODE)

HALBPALETTE
80 x 60 CM
HALF PALLET
80 x 60 CM

- 06 — terracotta / terracotta
- 08 — braun / brown
- 38 — anthrazit / anthracite



CYLINDRO BLUMENTÖPFE & UNTERSETZER — DISPLAYBOX EINFARBIG

CYLINDRO FLOWER POTS & SAUCERS — DISPLAY BOX ONE COLOUR

ART.-NR. 541 112 + .. (FARBCODE)

MODEL + COLOUR CODE

ART.-NR. + FARBCODE MODEL + COLOUR CODE	GRÖSSE CA. Ø SIZE APPR.	MENGE/STÜCK QUANTITY/PIECE
641 030 + ..	Blumentopf, 30 cm Flower pot	60
641 040 + ..	Blumentopf, 40 cm Flower pot	46
642 029 + ..	Untersetzer, 29 cm Saucer	60
642 037 + ..	Untersetzer, 37 cm Saucer	46
gesamt/total		212

**FARBCODE
COLOUR CODE**

- 06— terracotta / terracotta
- 38— anthrazit / anthracite

Hinweis: Farbigkeit der Verpackungskartons (Displayboxen) kann abweichen. /
Please note: The colour of the display boxes may vary.

EINZELPRODUKT: CYLINDRO BLUMENTOPF — 102
INDIVIDUAL PRODUCT: CYLINDRO FLOWER POT

EINZELPRODUKT: CYLINDRO UNTERSETZER — 202
INDIVIDUAL PRODUCT: CYLINDRO SAUCER

CYLINDRO BLUMENTÖPFE & UNTERSETZER — DISPLAYBOX GEMISCHT

CYLINDRO FLOWER POTS & SAUCERS — DISPLAY BOX ASSORTED

ART.-NR. 543 006 38

MODEL

ART.-NR. EINZELPRODUKT MODEL INDIVIDUAL PRODUCT	BEZEICHNUNG, GRÖSSE CA. Ø DESCRIPTION, SIZE APPR.	MENGE/STÜCK QUANTITY/PIECE
641 025 06 641 025 38	Blumentopf, 25 cm Flower pot	40 30
641 030 06 641 030 38	Blumentopf, 30 cm Flower pot	30 20
641 035 06 641 035 38	Blumentopf, 35 cm Flower pot	30 20
641 040 06 641 040 38	Blumentopf, 40 cm Flower pot	30 20
641 050 06 641 050 38	Blumentopf, 50 cm Flower pot	15 10
642 025 06 642 025 38	Untersetzer, 25 cm Saucer	30 20
642 029 06 642 029 38	Untersetzer, 29 cm Saucer	30 20
642 033 06 642 033 38	Untersetzer, 33 cm Saucer	30 20
642 037 06 642 037 38	Untersetzer, 37 cm Saucer	30 20
642 045 06 642 045 38	Untersetzer, 45 cm Saucer	15 10
gesamt/total		470



**HALBPALETTE
80 x 60 CM**
HALF PALLET
80 x 60 CM

**FARBlich SORTIERT (FARBCODE)
ASSORTED COLOURS (COLOUR CODE)**

- 06 — terracotta / terracotta
- 38 — anthrazit / anthracite

EINZELPRODUKT: CYLINDRO BLUMENTOPF — 102
INDIVIDUAL PRODUCT: CYLINDRO FLOWER POT

EINZELPRODUKT: CYLINDRO UNTERSETZER — 202
INDIVIDUAL PRODUCT: CYLINDRO SAUCER

NORA PFLANZCONTAINER & UNTERSETZER — DISPLAYBOX

NORA PLANT CONTAINER & SAUCERS — DISPLAY BOX

ART.-NR 587 006 38

MODEL

ART.-NR. EINZELPRODUKT MODEL INDIVIDUAL PRODUCT	BEZEICHNUNG, GRÖSSE CA. Ø DESCRIPTION, SIZE APPR.	MENGE/STÜCK QUANTITY/PIECE
687 028 06 687 028 38	Pflanzcontainer, 28 cm Plant container	50 50
687 033 06 687 033 38	Pflanzcontainer, 33 cm Plant container	25 25
687 040 06 687 040 38	Pflanzcontainer, 40 cm Plant container	20 20
688 025 06 688 025 38	Untersetzer, 25 cm Saucer	50 50
688 029 06 688 029 38	Untersetzer, 29 cm Saucer	25 25
688 035 06 688 035 38	Untersetzer, 35 cm Saucer	20 20
gesamt/total		380

EINZELPRODUKT: NORA PFLANZCONTAINER — 108
INDIVIDUAL PRODUCT: NORA PFLANZCONTAINER

EINZELPRODUKT: NORA UNTERSETZER — 205
INDIVIDUAL PRODUCT: NORA SAUCER



**EUROPALETTE
120 x 80 CM**
EURO PALLET
120 x 80 CM

**FARBlich SORTIERT (FARBCODE)
ASSORTED COLOURS (COLOUR CODE)**

- 06 — terracotta / terracotta
- 38 — anthrazit / anthracite

E&K PFLANZTOPF 2-FARBIG — DISPLAYBOX

E&K PLANTER TWO-COLOURED — DISPLAY BOX

ART.-NR 531 100 91

MODEL

ART.-NR. EINZELPRODUKT MODEL INDIVIDUAL PRODUCT	BEZEICHNUNG, GRÖSSE CA. Ø DESCRIPTION, SIZE APPR.	MENGE/STÜCK QUANTITY/PIECE
310 025 88	Pflanztopf, 25 cm Planter	18
310 025 89	Pflanztopf, 25 cm Planter	18
310 030 88	Pflanztopf, 30 cm Planter	32
310 030 89	Pflanztopf, 30 cm Planter	32
310 040 88	Pflanztopf, 40 cm Planter	17
310 040 89	Pflanztopf, 40 cm Planter	16
gesamt/total		133

EINZELPRODUKT: E&K PFLANZTOPF, 2-FARBIG — 112
INDIVIDUAL PRODUCT: E&K PFLANTER TWO-COLOURED



**EUROPALETTE
120 x 80 CM**
EURO PALLET
120 x 80 CM

**FARBlich SORTIERT (FARBCODE)
ASSORTED COLOURS (COLOUR CODE)**

- 88 — eukalyptus & weiß / eucalyptus & white
- 89 — blaugrau & weiß / blue-grey & white



RILLEN PFLANZTOPF KUBUS QUADRAT — DISPLAYBOX
GROOVED PLANTER KUBUS SQUARE — DISPLAY BOX

ART.-NR. 535 996 99
MODEL

ART.-NR. EINZELPRODUKT MODEL INDIVIDUAL PRODUCT	GRÖSSE CA. SIZE APPR.	MENGE/STÜCK QUANTITY/PIECE
165 030 38	30	10
165 030 58		4
165 040 38	40	10
165 040 58		4
165 050 38	50	3
165 050 58		1
gesamt/total		32

EINZELPRODUKT: RILLEN PFLANZTOPF KUBUS QUADRAT — 142
INDIVIDUAL PRODUCT: GROOVED PLANTER KUBUS SQUARE



EUROPALETTE
120 x 80 CM
EURO PALLET
120 x 80 CM

FARBlich SORTIERT (FARBCODE)
ASSORTED COLOURS
(COLOUR CODE)

- 38 — anthrazit / anthracite
- 58 — betonfarbe / concrete colour

RILLEN PFLANZTOPF RUND — DISPLAYBOX
GROOVED PLANTER ROUND — DISPLAY BOX

ART.-NR. 553 000 96
MODEL

ART.-NR. EINZELPRODUKT MODEL INDIVIDUAL PRODUCT	GRÖSSE CA. SIZE APPR.	MENGE/STÜCK QUANTITY/PIECE
153 031 38	30	10
153 031 58		4
153 060 38	60	3
153 060 58		1
158 040 38	40	9
158 040 58		3
gesamt/total		30

EINZELPRODUKT: RILLEN PFLANZTOPF RUND — 140
INDIVIDUAL PRODUCT: GROOVED PLANTER ROUND

FARBlich SORTIERT (FARBCODE)
ASSORTED COLOURS (COLOUR CODE)

- 38 — anthrazit / anthracite
- 58 — betonfarbe / concrete colour

Hinweis: Farbigkeit der Verpackungskartons (Displayboxen) kann abweichen. / Please note: The colour of the display boxes may vary.

RILLEN PFLANZTOPF QUADRAT & RUND — DISPLAYBOX
GROOVED PLANTER SQUARE & ROUND — DISPLAY BOX

ART.-NR. 553 000 94
MODEL

ART.-NR. EINZELPRODUKT MODEL INDIVIDUAL PRODUCT	GRÖSSE CA. SIZE APPR.	MENGE/STÜCK QUANTITY/PIECE
153 031 38	30	7
153 031 58		7
153 060 38	60	3
153 060 58		3
158 040 38	40	4
158 040 58		4
gesamt/total		28

EINZELPRODUKT: RILLEN PFLANZTOPF QUADRAT — 138
INDIVIDUAL PRODUCT: GROOVED PLANTER SQUARE

EINZELPRODUKT: RILLEN PFLANZTOPF RUND — 140
INDIVIDUAL PRODUCT: GROOVED PLANTER ROUND



EUROPALETTE
120 x 80 CM
EURO PALLET
120 x 80 CM

FARBlich SORTIERT (FARBCODE)
ASSORTED COLOURS
(COLOUR CODE)

- 38 — anthrazit / anthracite
- 58 — betonfarbe / concrete colour

KUBUS PFLANZGEFÄSS QUADRATISCH — DISPLAYBOX
KUBUS PLANTER SQUARE — DISPLAY BOX

ART.-NR. 535 999 38
MODEL

ART.-NR. EINZELPRODUKT MODEL INDIVIDUAL PRODUCT	GRÖSSE CA. SIZE APPR.	MENGE/STÜCK QUANTITY/PIECE
133 030 38	30	10
133 040 38	40	10
133 050 38	50	4
134 080 38	80	4
gesamt/total		28

EINZELPRODUKT: KUBUS PFLANZGEFÄSS QUADRATISCH — 130
INDIVIDUAL PRODUCT: KUBUS PLANTER SQUARE



EUROPALETTE
120 x 80 CM
EURO PALLET
120 x 80 CM

FARBlich SORTIERT (FARBCODE)
ASSORTED COLOURS
(COLOUR CODE)

- 38 — anthrazit / anthracite



STONE KUBUS — DISPLAYBOX

STONE KUBUS — DISPLAY BOX

ART.-NR. 535 995 99

MODEL

ART.-NR. EINZELPRODUKT MODEL INDIVIDUAL PRODUCT	GRÖSSE CA. SIZE APPR.	MENGE/STÜCK QUANTITY/PIECE
166 030 38	30	10
166 030 58		4
166 040 38	40	10
166 040 58		4
166 050 38	50	3
166 050 58		1
gesamt/total		32

EINZELPRODUKT: STONE KUBUS — 152
INDIVIDUAL PRODUCT: STONE KUBUS



FARBLICH SORTIERT (FARBCODE)
ASSORTED COLOURS (COLOUR CODE)

- 38 — anthrazit / anthracite
- 58 — betonfarbe / concrete colour

EUROPALETTE
120 x 80 CM
EURO PALLET
120 x 80 CM

PALERMO PFLANZTOPF — DISPLAYBOX

PALERMO PLANTER — DISPLAY BOX

ART.-NR. 521 001 + .. (FARBCODE)

MODEL + COLOUR CODE

ART.-NR. EINZELPRODUKT MODEL INDIVIDUAL PRODUCT	GRÖSSE CA. Ø SIZE APPR.	MENGE/STÜCK QUANTITY/PIECE
121 030 + ..	30	26
121 040 + ..	40	10
121 050 + ..	50	8
121 060 + ..	60	6
gesamt/total		50

EINZELPRODUKT: PALERMO PFLANZTOPF — 172
INDIVIDUAL PRODUCT: PALERMO PLANTER

Abb. / Fig.
521 001 38



FARBCODE
COLOUR CODE

- 37 — impruneta / impruneta
- 38 — anthrazit / anthracite

EUROPALETTE
120 x 80 CM
EURO PALLET
120 x 80 CM

MILANO PFLANZTOPF — DISPLAYBOX GEMISCHT

MILANO PLANTER — DISPLAY BOX ASSORTED

ART.-NR. 510 030 99

MODEL

ART.-NR. EINZELPRODUKT MODEL INDIVIDUAL PRODUCT	GRÖSSE CA. Ø SIZE APPR.	MENGE/STÜCK QUANTITY/PIECE
110 030 37	30	25
110 030 38		20
110 035 37	35	8
110 035 38		6
gesamt/total		59

EINZELPRODUKT: MILANO PFLANZTOPF — 174
INDIVIDUAL PRODUCT: MILANO PLANTER

FARBLICH SORTIERT (FARBCODE)
ASSORTED COLOURS (COLOUR CODE)

- 37 — impruneta / impruneta
- 38 — anthrazit / anthracite

HALBPALETTE
80 x 60 CM
HALF PALLET
80 x 60 CM



MILANO PFLANZTOPF — DISPLAYBOX EINFARBIG

MILANO PLANTER — DISPLAY BOX ONE COLOUR

ART.-NR. 510 000 + .. (FARBCODE)

MODEL + COLOUR CODE

ART.-NR. EINZELPRODUKT MODEL INDIVIDUAL PRODUCT	GRÖSSE CA. Ø SIZE APPR.	MENGE/STÜCK QUANTITY/PIECE
110 030 + ..	30	34
110 035 + ..	35	56
110 040 + ..	40	42
110 055 + ..	55	18
gesamt/total		150

EINZELPRODUKT: MILANO PFLANZTOPF — 174
INDIVIDUAL PRODUCT: MILANO PLANTER

FARBCODE
COLOUR CODE

- 37 — impruneta / impruneta
- 38 — anthrazit / anthracite

Hinweis: Farbigkeit der Verpackungskartons (Displayboxen) kann abweichen. / Please note: The colour of the display boxes may vary.

Displayständer

Display stand



KOSTENFREI ERHÄLTLICHER DISPLAYSTÄNDER AB MINDESTBESTELLMENGE (SIEHE UNTEN).
 FREE DISPLAY STAND PROVIDED WHEN YOU EXCEED THE MINIMUM ORDER QUANTITY (SEE BELOW).

DIE ABBILDUNG DES DISPLAYSTÄNDERS CAPRI WEICHT VOM ORIGINAL LEICHT AB. THE ILLUSTRATION OF THE CAPRI DISPLAY STAND DIFFERS SLIGHTLY FROM THE ORIGINAL.



+



Präsentation rundum:

Unser Displayständer CAPRI

Ab einer Bestellmenge von 80 Blumengießkannen und 80 Sprüher, können Sie den Displayständer CAPRI als separat aufgeführte Bestellposition unter angegebener Art.-Nr. 547 000 99 ohne Bestückung kostenfrei erhalten.

PRESENTATION ALL AROUND: OUR DISPLAY STAND CAPRI
 From an order volume of 80 flower watering cans and 80 sprayers, you will receive the display stand CAPRI free of charge as a separately listed order item under the article number 547 000 99 without equipment.

CAPRI BLUMENGIESSKANNE UND SPRÜHER – DISPLAYSTÄNDER

CAPRI WATERING CAN AND SPRAYER – DISPLAY STAND

ART.-NR. 547 000 99
 MODEL

PASSEND FÜR ART.-NR. MATCHING MODEL	BEZEICHNUNG, INHALT CA. DESCRIPTION, VOLUME APPR.	VE PU	MENGE/STÜCK QUANTITY/PIECE
753 001 + ..	Blumengießkanne CAPRI, 1,3 Liter Watering can CAPRI, 1,3 litres	5	individuell kombinierbar individually combinable
754 007 + ..	Sprüher CAPRI, 0,75 Liter Sprayer CAPRI, 0,75 litres	5	individuell kombinierbar individually combinable



OHNE BESTÜCKUNG
 WITHOUT EQUIPMENT

VERFÜGBARE FARBEN (FARBCODE)
 AVAILABLE COLOURS (COLOUR CODE)

- 10 – weiß / white
- 70 – transparent klar / transparent clear
- 59 – betonfarbe / concrete colour
- 69 – transparent anthrazit / transparent anthracite
- 68 – eukalyptus / eucalyptus
- 74 – transparent eukalyptus / transparent eucalyptus
- 86 – zartrosa / soft pink
- 75 – transparent zartrosa / transparent soft pink

EINZELPRODUKT: CAPRI BLUMENGIESSKANNE – 32
 INDIVIDUAL PRODUCT: CAPRI WATERING CAN

EINZELPRODUKT: CAPRI SPRÜHER – 32
 INDIVIDUAL PRODUCT: CAPRI SPRAYER





Displayständer

Display stand

CYLINDRO BLUMENTÖPFE & UNTERSETZER – DISPLAYSTÄNDER

CYLINDRO FLOWER POTS & SAUCERS – DISPLAY STAND

ART.-NR. 100 641 + .. (FARBCODE)
MODEL + COLOUR CODE

FARBCODE
COLOUR CODE

ART.-NR. EINZELPRODUKT MODEL INDIVIDUAL PRODUCT	BEZEICHNUNG, GRÖSSE CA. Ø DESCRIPTION, SIZE APPR.	MENGE/STÜCK QUANTITY/PIECE
641 012 + ..	Blumentopf Cylindro, 12 cm Flower pot	50
641 016 + ..	Blumentopf Cylindro, 16 cm Flower pot	40
641 020 + ..	Blumentopf Cylindro, 20 cm Flower pot	30
641 025 + ..	Blumentopf Cylindro, 25 cm Flower pot	20
641 030 + ..	Blumentopf Cylindro, 30 cm Flower pot	20
641 035 + ..	Blumentopf Cylindro, 35 cm Flower pot	18
641 040 + ..	Blumentopf Cylindro, 40 cm Flower pot	14
641 045 + ..	Blumentopf Cylindro, 45 cm Flower pot	10
642 013 + ..	Untersetzer Cylindro, 13 cm Saucer	70
642 017 + ..	Untersetzer Cylindro, 17 cm Saucer	60
642 021 + ..	Untersetzer Cylindro, 21 cm Saucer	50
642 025 + ..	Untersetzer Cylindro, 25 cm Saucer	40
642 029 + ..	Untersetzer Cylindro, 29 cm Saucer	40
642 033 + ..	Untersetzer Cylindro, 33 cm Saucer	50
642 037 + ..	Untersetzer Cylindro, 37 cm Saucer	50
642 041 + ..	Untersetzer Cylindro, 41 cm Saucer	60

- 06 – terracotta / terracotta
- 38 – anthrazit / anthracite
- 40 – taupe / taupe

CYLINDRO

DISPLAYREGAL
DISPLAY RACK

EINZELPRODUKT: CYLINDRO BLUMENTOPF – 102
INDIVIDUAL PRODUCT: CYLINDRO FLOWER POT

EINZELPRODUKT: CYLINDRO UNTERSETZER – 202
INDIVIDUAL PRODUCT: CYLINDRO SAUCER





STANDARD BLUMENTOPF & UNTERSETZER

DISPLAYREGAL
DISPLAY RACK

Displayständer

Display stand

STANDARD BLUMENTÖPFE & UNTERSETZER – DISPLAYSTÄNDER

STANDARD FLOWER POTS & SAUCERS – DISPLAY STAND



ART.-NR. 100 806 + .. (FARBCODE)

MODEL + COLOUR CODE

FARBCODE

COLOUR CODE

ART.-NR. EINZELPRODUKT MODEL INDIVIDUAL PRODUCT	BEZEICHNUNG, GRÖSSE CA. Ø DESCRIPTION, SIZE APPR.	MENGE/STÜCK QUANTITY/PIECE
806 012 + ..	Blumentopf, 12 cm Flower pot	20
806 014 + ..	Blumentopf, 14 cm Flower pot	50
806 016 + ..	Blumentopf, 16 cm Flower pot	40
806 020 + ..	Blumentopf, 20 cm Flower pot	30
806 024 + ..	Blumentopf, 24 cm Flower pot	30
806 028 + ..	Blumentopf, 28 cm Flower pot	20
806 032 + ..	Blumentopf, 32 cm Flower pot	15
806 040 + ..	Blumentopf, 40 cm Flower pot	10
808 010 + ..	Untersetzer, 10 cm Saucer	120
808 012 + ..	Untersetzer, 12 cm Saucer	120
808 016 + ..	Untersetzer, 16 cm Saucer	120
808 021 + ..	Untersetzer, 21 cm Saucer	100
808 024 + ..	Untersetzer, 24 cm Saucer	100
808 030 + ..	Untersetzer, 30 cm Saucer	90
808 034 + ..	Untersetzer, 34 cm Saucer	90
808 040 + ..	Untersetzer, 40 cm Saucer	70

06 – terracotta / terracotta

07 – braun / brown

38 – anthrazit / anthracite

EINZELPRODUKT: STANDARD BLUMENTOPF – 98
INDIVIDUAL PRODUCT: STANDARD FLOWER POT

EINZELPRODUKT: STANDARD UNTERSETZER – 200
INDIVIDUAL PRODUCT: STANDARD SAUCER



Displayständer

Display stand

NEVADA BLUMENTÖPFE — DISPLAYSTÄNDER

NEVADA FLOWER POTS — DISPLAY STAND

ART.-NR. 100 807 + .. (FARBCODE)

MODEL + COLOUR CODE

ART.-NR. EINZELPRODUKT MODEL INDIVIDUAL PRODUCT	BEZEICHNUNG, GRÖSSE CA. Ø DESCRIPTION, SIZE APPR.	MENGE/STÜCK QUANTITY/PIECE
807 010 + ..	Blumentopf Nevada, 10 cm Flower pot	40
807 012 + ..	Blumentopf Nevada, 12 cm Flower pot	40
807 013 + ..	Blumentopf Nevada, 13 cm Flower pot	40
807 015 + ..	Blumentopf Nevada, 15 cm Flower pot	35
807 017 + ..	Blumentopf Nevada, 17 cm Flower pot	60
807 020 + ..	Blumentopf Nevada, 20 cm Flower pot	50
807 024 + ..	Blumentopf Nevada, 24 cm Flower pot	50
807 027 + ..	Blumentopf Nevada, 27 cm Flower pot	40
807 032 + ..	Blumentopf Nevada, 32 cm Flower pot	30
807 035 + ..	Blumentopf Nevada, 35 cm Flower pot	30

EINZELPRODUKT: NEVADA BLUMENTOPF — 100
INDIVIDUAL PRODUCT: NEVADA FLOWER POT

FARBCODE

COLOUR CODE

- 06 — terracotta / terracotta
- 38 — anthrazit / anthracite

Präsenter

Präsenter

HALTER FÜR BLUMENKASTENHALTER — PRÄSENTER

HOLDER FOR FLOWER BOX BRACKETS – DISPLAY

ART.-NR. 100 811 98

MODEL



IM REGAL CA. 1,3 M BREIT
APPROXIMATELY 1.3 M WIDE
ON THE SHELF



Informationen

Informations

Rohstoffe

Unsere Umwelt liegt uns am Herzen! Unsere Produkte sind ausschließlich aus recyclingfähigen Kunststoffen hergestellt und mit den entsprechenden Recyclingzeichen versehen. Wir verarbeiten nur Kunststoffe, die keine belastenden Zusätze enthalten. Zur Einfärbung unserer Rohstoffe verwenden wir nur cadmiumfreie Farben.



Verpackung

Wir sind stets bemüht, unsere Verpackung zu optimieren, das heißt, nur das absolut Notwendigste an Verpackungsmaterial einzusetzen. Oft sind unsere Verpackungseinheiten nur mit einem Klebeband versehen. Auch hier beweisen wir unsere Verantwortung für unsere Umwelt.

Lieferzeiten

Ihre Bestellung wird immer termingerecht ausgeführt. Alle Möglichkeiten der Verladung bieten hier die optimalen Voraussetzungen, auf Ihre Wünsche sofort zu reagieren. Ob per Spedition oder Paketdienst - wir werden immer die schnellste und kostengünstigste Versandart für Sie auswählen.

Daten

Wir bieten unseren Kunden die Möglichkeit des papierlosen Datenaustausches durch EDI. Derzeit sind in unserem Hause die Datenformate Orders, Desadv und Invoice realisiert. Durch unser hochmodernes virtualisiertes EDV-System und die Sendungsverfolgung über Internet kann unser Verkauf jederzeit Auskunft über den Status Ihrer Aufträge geben.

EAN-Code

Wir zeichnen alle Artikel (außer Zubehör) mit unseren EAN-Nummern aus.

RAW MATERIALS

Our environment is our priority! Our products are entirely made of recyclable plastics and show the appropriate recycling symbol. We only use plastics that contain no harmful additives. For the colouring of our raw materials we use cadmium-free colours only.

PACKAGING

We are constantly striving to improve our packaging, which means we only use the minimum of packaging material. Our packs are often provided with just a tape. This again shows our responsibility for our environment.

DELIVERY TIME

Your order will always be executed on time. Various shipping opportunities offer the best conditions to respond to your requests immediately. Whether by carrier or parcel service - we will always choose the quickest and most cost-effective shipping solution for you.

DATA

We offer our customers the option of paperless data exchange through EDI. We have implemented the data formats Orders, Desadv and Invoice. With our state of the art virtualized computer system and the usage of internet parcel tracking we may inform you at any time about the status of your orders.

EAN CODE

We label all items (except accessories) with our EAN numbers.

Vertreterliste

List of representatives

NAME E-MAIL NAME E-MAIL	TELEFON PHONE	TELEFAX FAX	MOBIL MOBILE	PLZ-GEBIETE POSTCODE AREAS
Agentur Mahler handelsvertretung-mahler@gmx.de			0171-6533835	80000 - 82999 85000 - 87999 88000 - 88199 BY 89200 - 89499
Agentur HAICON pfaff@hai-con.de p.pfaff@hai-con.de	08233-7947450	08233-79474510	0160/96962099 0157/30223800	63600 - 63999 BY 83000 - 84999 90000 - 91000 91001 - 91799 92000 - 96999 97000 - 97799
Agentur Thoma thoma-michael@gmx.de thoma-sebastian@outlook.de	07941-98304	07941-98305	0172-9342952 0177/1761010	68000 - 76699 77000 - 79999 88000 - 88199 88200 - 89199 BW 89500 - 89999 97800 - 97999
Agentur Klos klos-handelsvertretungen@t-online.de	06897-966396	06897-966398	0176-22052670	54000 - 56999 66000 - 67999 76700 - 76999
Agentur Rosche roland.rosche@web.de	06094-989580		0172-9794388	34000 - 36999 37200 - 37299 60000 - 63599 63600 - 63999 HE 64000 - 65999
Agentur Böhm boehm-handelsagentur@t-online.de			0170-8120000	32000 - 33999 44000 - 44699 48000 - 48999 59000 - 59559
Agentur Brinkwirth u.brinkwirth@gmail.com			0171-2147279	57000 - 57999 58000 - 58999 59560 - 59999
Agentur Gielen hvgielen@arcor.de			0171-7738597	40000 - 43999 44700 - 47999 50000 - 53999
Agentur Sallein f.sallein@t-online.de	04206-1696	04206-9874	0163-4169610	17000 - 31999 37000 - 37199 37293 - 37699 38000 - 38799 49000 - 49999
Agentur Hannig hannig-halsbruecke@t-online.de	03731-218031		0172-9115961	01000 - 03999 08000 - 09999 10000 - 16999
Agentur Strese strese.hv@gmail.com			0172-3661025	04000 - 04999 06000 - 06999 39000 - 39999
Agentur Arnold hv.markus.arnold@gmail.com			0177-3084255	07000 - 07999 36000 - 38899 98000 - 99999
Agentur Meulemans alain.meulemans@telenet.be			+ 32 476 59 96 97	Belgium
Agentur Wacht info@rwhandel.at			+ 43 676 430 4578	Austria
Green and Home Ltd david@greenandhome.co.uk	+ 44 1992 92 49 74		+ 44 7515 28 70 64	Great Britain
Scan-Pot ApS scanpot@scanpot.dk	+ 45 7443 1411	+ 45 7443 1445	+ 45 4053 1410	Denmark - Finland Norway - Sweden



Beispiele / Examples

Glossar

Glossary

Antiqua Gartengießkanne / Garden watering can	26	Milly Übertopf / Cachepot	46
Aqua Andaluca Bewässerungsblumenkasten / Self-watering flower box	76	Montana Blumentopf / Flower pot	104
Aqua Flor Bewässerungsblumenkasten / Self-watering flower box	80	Montana Untersetzer / Saucer	204
Aqua Green Bewässerungsblumenkasten / Self-watering flower box	72	Napoli Jardiniere / Planter	160
Aqua Palido Bewässerungsblumenkasten / Self-watering flower box	70	Napoli Schale / Bowl	161
Aqua Toscana Bewässerungsblumenkasten / Self-watering flower box	74	Napoli Pflanztopf / Planter	158
Aufhänger für Galicia Hängeampel / Hanger for Galicia	212	Neo-Line Bewässerungsblumenkasten / Self-watering flower box	68
Auslaufhahn für Kanister / Pourer for canister	212	Nevada Blumentopf / Flower pot	100
Azteki Pflanztopf / Flower pot	106	Nora Pflanzcontainer / Plant container	108
Baumcontainer / Tree container	118	Nora Untersetzer / Saucer	205
Beedabei Bewässerungsblumenkasten / Self-watering flower box	78	Olivera Jardiniere Pflanzgefäß / Planter	90
Bergamo Blumenkasten / Flower box	62	Orchideenstäbe / Orchid rods	211
Bewässerungseinsatz für Blumenkästen / Watering system for flower box	213	Orchideentopf / Orchid pot	52
Bianca Untersetzer eckig / Saucer square	208	Orchideentopf Untersetzer / Orchid pot saucer	210
Blumengießkanne / Flower watering can	24	Palermo Pflanztopf / Planter	172
Blumenkastenhalter / Flower box bracket	196	Parma Pflanzgefäß / Planter	176
Blumenspindel / Urn planter	116	Pflanzcontainer mit Griff / Plant container with handle	118
Capri Blumengießkanne und Sprüher / Watering can and Sprayer	32	Plato Pflanztrog / Plant trough	114
Casablanca Übertopf / Cachepot	48	Plato Untersetzer / Saucer	209
Conny Wand- und Geländertopf / Wall and railing planter	88	Pure Übertopf / Cachepot	50
Containertopf / Container pot	117	Ravenna Pflanztopf / Planter	178
Cylindro Blumentopf / Flower pot	102	Recy Gartengießkanne / Garden watering can	20
Cylindro Untersetzer / Saucer	202	Rillen Schale quadrat / Grooved bowl square	146
Dropman Wasserreservoir / Water container	185	Rillen Schale rund / Grooved bowl square	147
E&K Pflanztopf / E&K planter	110	Rillen Pflanztopf Kubus quadrat / Grooved planter Kubus square	142
E&K Pflanztopf mit Schrift / E&K planter with scripture	113	Rillen Pflanztopf quadrat / Grooved planter square	138
E&K Pflanztopf zweifarbig / E&K planter two-coloured	112	Rillen Pflanztopf rund / Grooved planter round	140
Easy Pflanzgefäß für Europalette / Planter for Euro pallets	86	Rillen Trog / Grooved through	144
Eden Blumengießkanne und Sprüher / Watering can and Sprayer	34	Rimini Jardiniere / Planter	166
Ersatzbrausen für Gießkannen / Replacement roses	212	Rimini Pflanztopf / Planter	164
Ersatzdeckel für E&K Hochbeet / Additional cover for E&K raised bed	212	Rimini Schale / Bowl	167
Fashion Blumengießkanne und Sprüher / Watering can and Sprayer	36	Standard Blumenkasten / Flower box	58
Flexikorb / Flexible basket	184	Standard Blumenkastenuntersetzer / Flower box saucer	193
Galicia Hängeampel / Hanging basket	124	Standard Pflanzschale / Bowl planter	127
Gartengießkanne / Garden watering can	22	Standard Blumentopf / Flower pot	98
Grabvase / Grave vase	186	Standard Sprüher / Sprayer	38
Große Ausführung Blumenkasten-Untersetzer / Flower box bracket	195	Standard Untersetzer / Saucer	200
Hochbeet E&K / Raised bed E&K	92	Stone Kubus / Kubus	152
Jessica Pflanzschale / Flower bowl	126	Stone Schale oval / Bowl oval	155
Kanister / Canister	188	Stone Pflanztopf rund / Pot round	150
Kubus Pflanzgefäß quadratisch / Planter square	130	Stone Pflanztopf quadrat / Pot square	154
Kubus Pflanzgefäß rechteckig / Planter rectangular	131	Toscana Blumenkasten / Flower box	60
Kubus Raumteiler / Partition	134	Toscana Blumenkastenuntersetzer / Flower box saucer	194
Kubus Pflanzgefäß Säule / Planter column	132	Tubo Übertopf / Cachepot	44
Kugeltopf / Round pot	181	Untersetzer Blumenkästen / Flower box saucer	192
Liv Übertopf / Cachepot	42	Untersetzer Töpfe / Pot saucer	200
Livorno Vase / Vase	180	Verstärkungsstrebe für Blumenkästen / Reinforcement strut	213
Marcella Untersetzer / Saucer	206	Viva Bewässerungsblumenkasten / Self-watering flower box	66
Maya Blumenkasten mit Wasserspeicher / Flower pot with water tank	82	Viva Pflanzgestell / Plant stand	66
Megalos Pflanztopf / Planter	170	Wasserstandsanzeiger / Water level indicator	213
Milano Pflanztopf / Planter	174	XXL Geländerblumenkasten / XXL railing planter	120
		XXL Geländerblumentopf / XXL railing flower pot	122



Verwaltung und Produktion

Geli GmbH
Am Goldbach 1
63755 Alzenau-Michelbach

Telefon +49 (0) 60 23 - 9717 - 0
info@geli.de

Verkauf und Logistikzentrum

Geli GmbH
Gewerbepark Birkenhain 12
63579 Freigericht - Bernbach

Telefon +49 (0) 60 51 - 8283 - 0
verkauf@geli.de

Allgemeine Anfragen oder Bestellungen

Bei allgemeinen Anfragen oder Bestellungen kontaktieren Sie bitte unser Verkaufsteam per E-Mail an verkauf@geli.de.

General enquiries or orders

For general inquiries or orders please contact our sales team by e-mail to verkauf@geli.de.

www.geli.de

